

PRINTING INSTRUCTIONS

We recommend printing at full-scale to check the fit with your tools before ordering.

Option 1: Print this page full-scale on a large-format printer (D-Size, 34 inches X 22 inches).

Option 2: Print page 2 - 9 on 8-1/2 X 11 inch paper and assemble.

Thank You!

THE INFORMATION CONTAINED ON THIS DRAWING IS THE SOLE PROPERTY OF FOAMFIT TOOLS AND MAY NOT BE USED WITHOUT PERMISSION.
Copyright 2016 FoamFit Tools

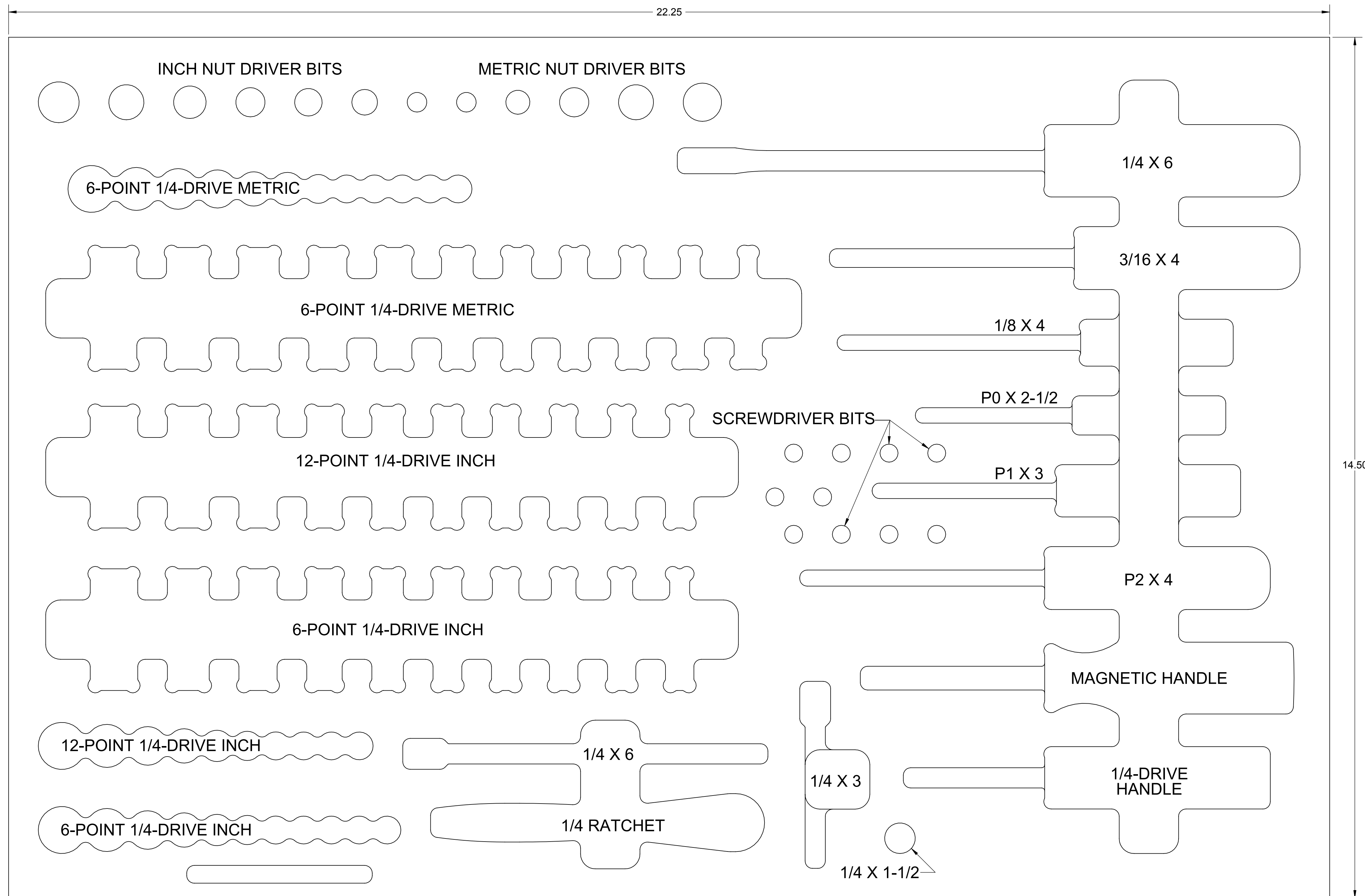
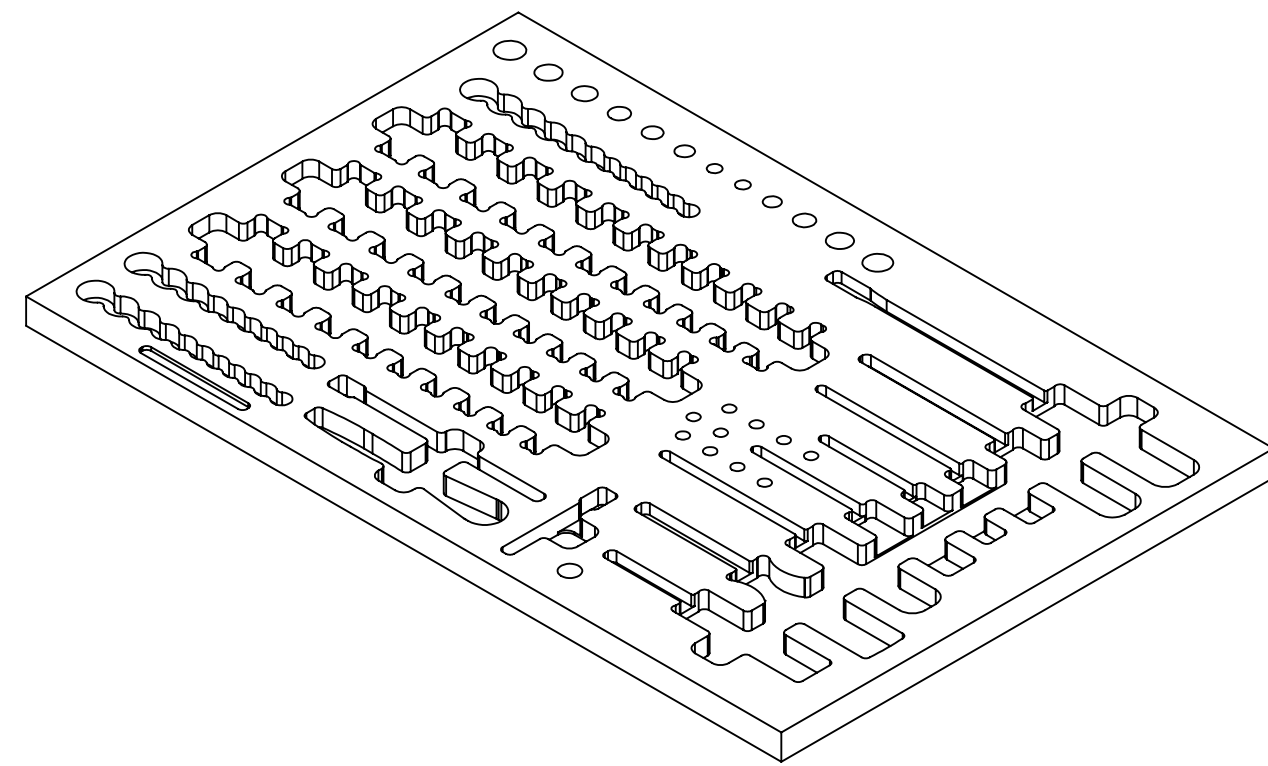

PART NUMBER
F1M-01326

1.00 IN

PAGE KEY



1.00
IN

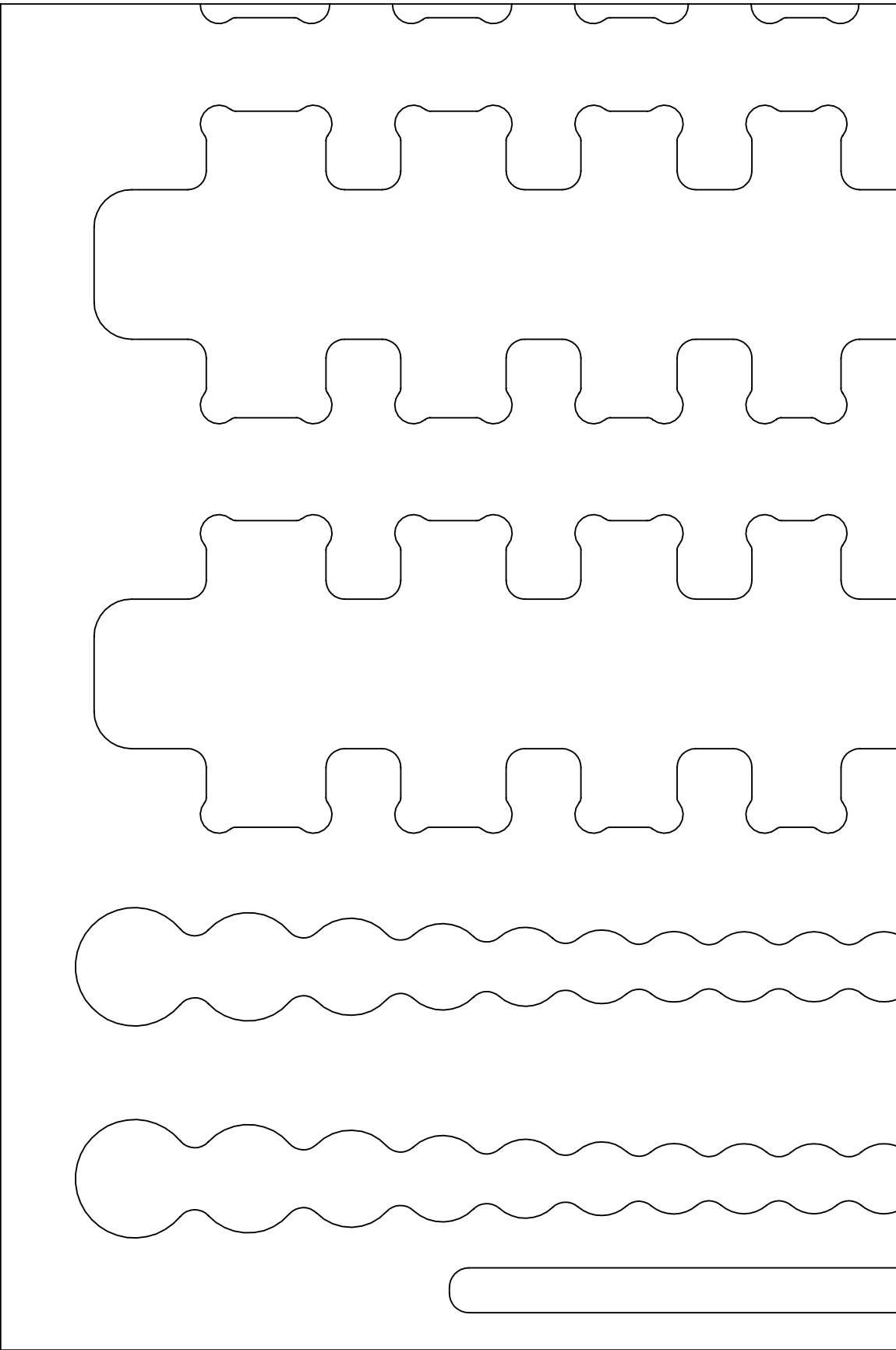

Print on Letter at 100%

DATE CREATED

02 FEB 2016

PART NUMBER

F1M-01326

1.00 IN

PAGE KEY



1.00
IN

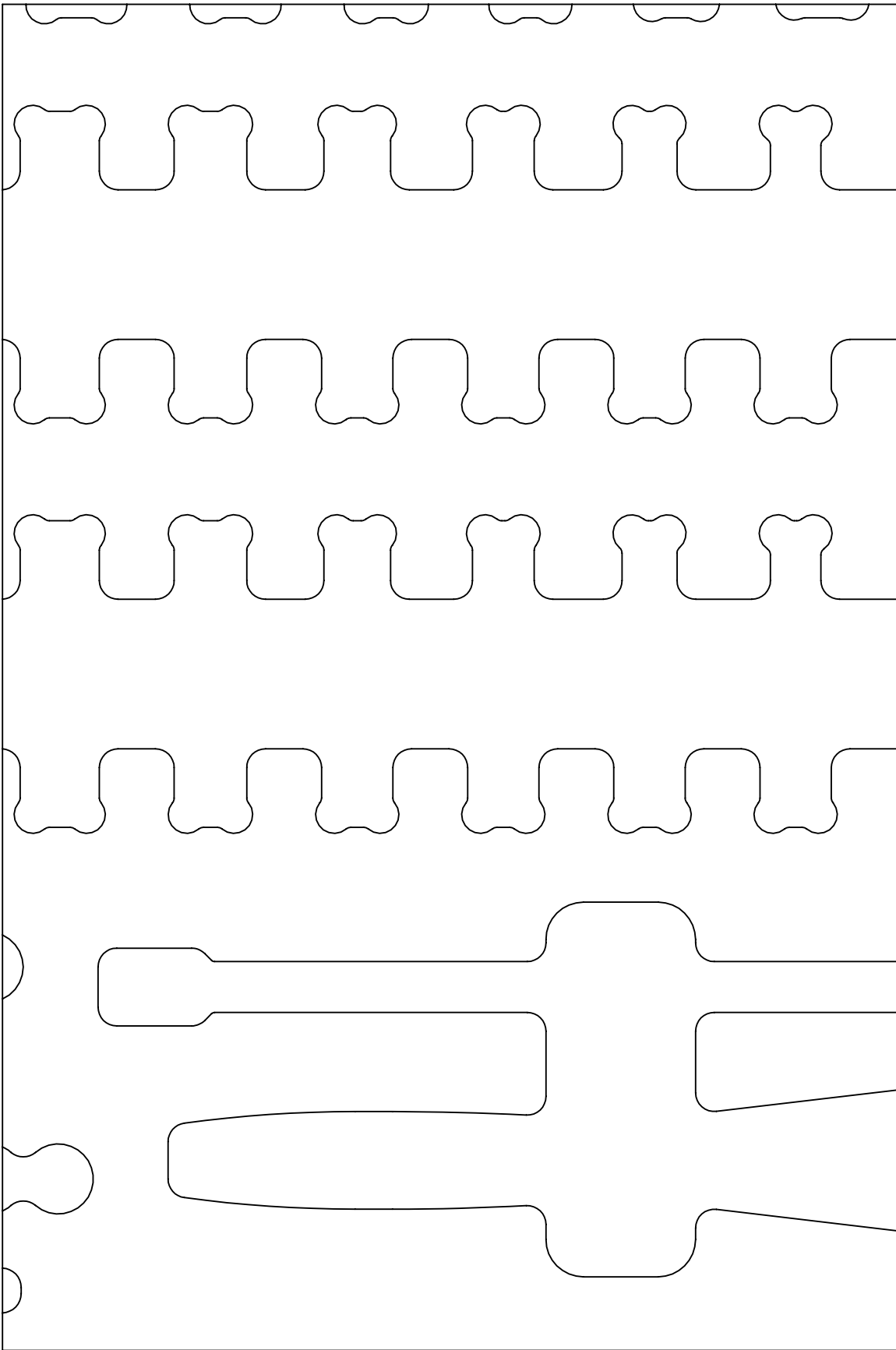

Print on Letter at 100%

DATE CREATED

02 FEB 2016

PART NUMBER

F1M-01326

Print on Letter at 100%

1.00
IN

1.00 IN

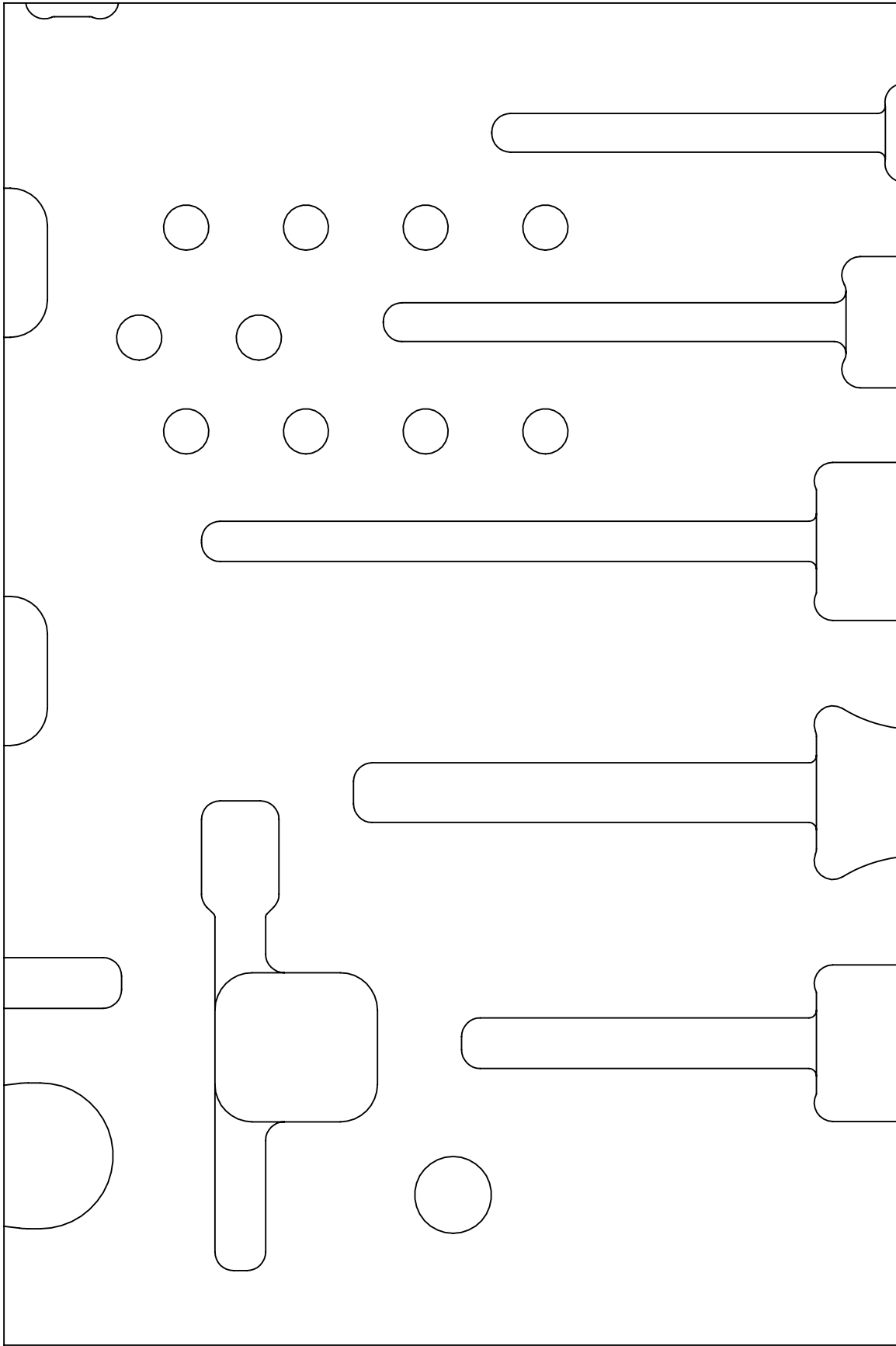

PAGE KEY



DATE CREATED

02 FEB 2016

PART NUMBER

F1M-01326

Print on Letter at 100%

1.00
IN

1.00 IN

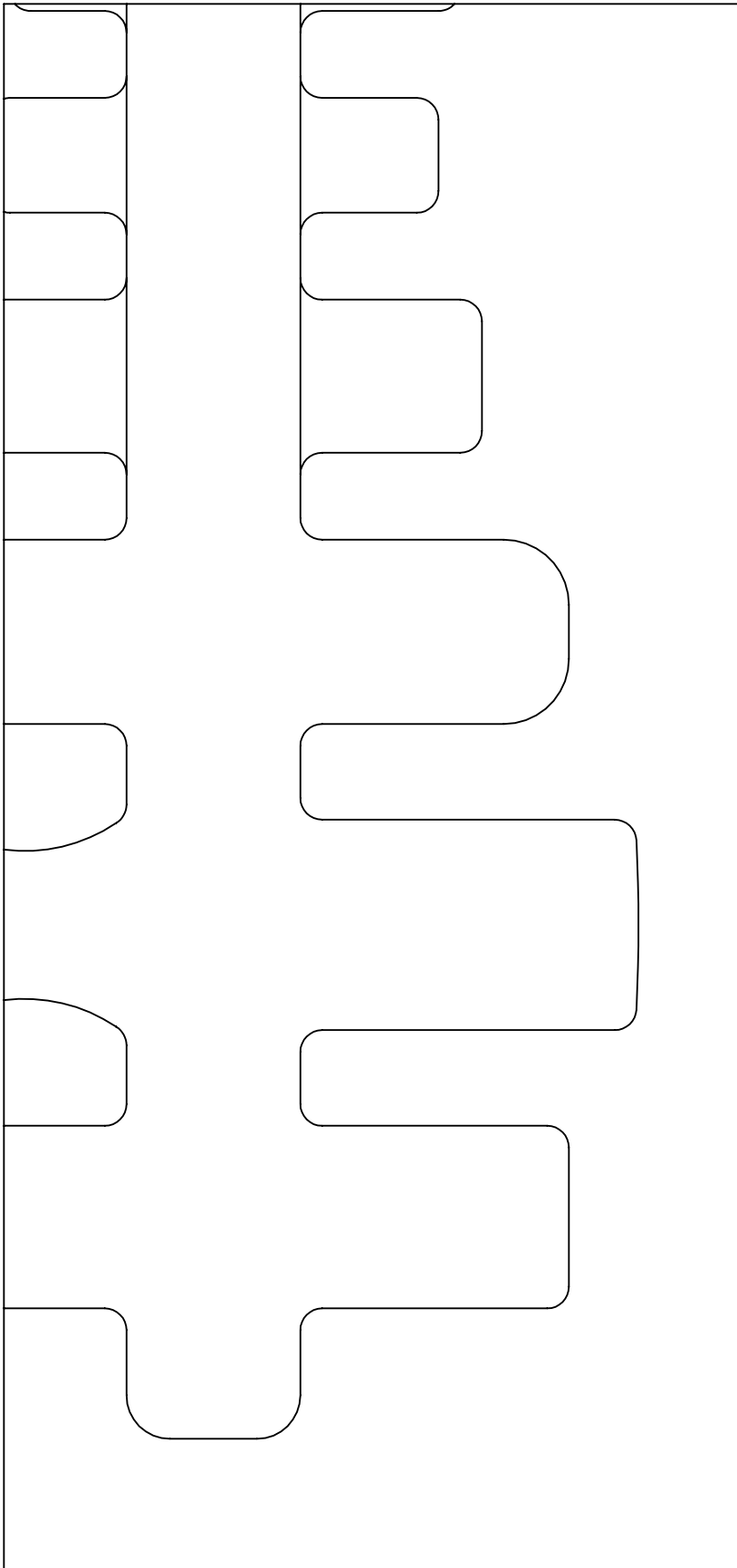

PAGE KEY



DATE CREATED

02 FEB 2016

PART NUMBER

F1M-01326

1.00 IN

PAGE KEY



1.00
IN

Print on Letter at 100%

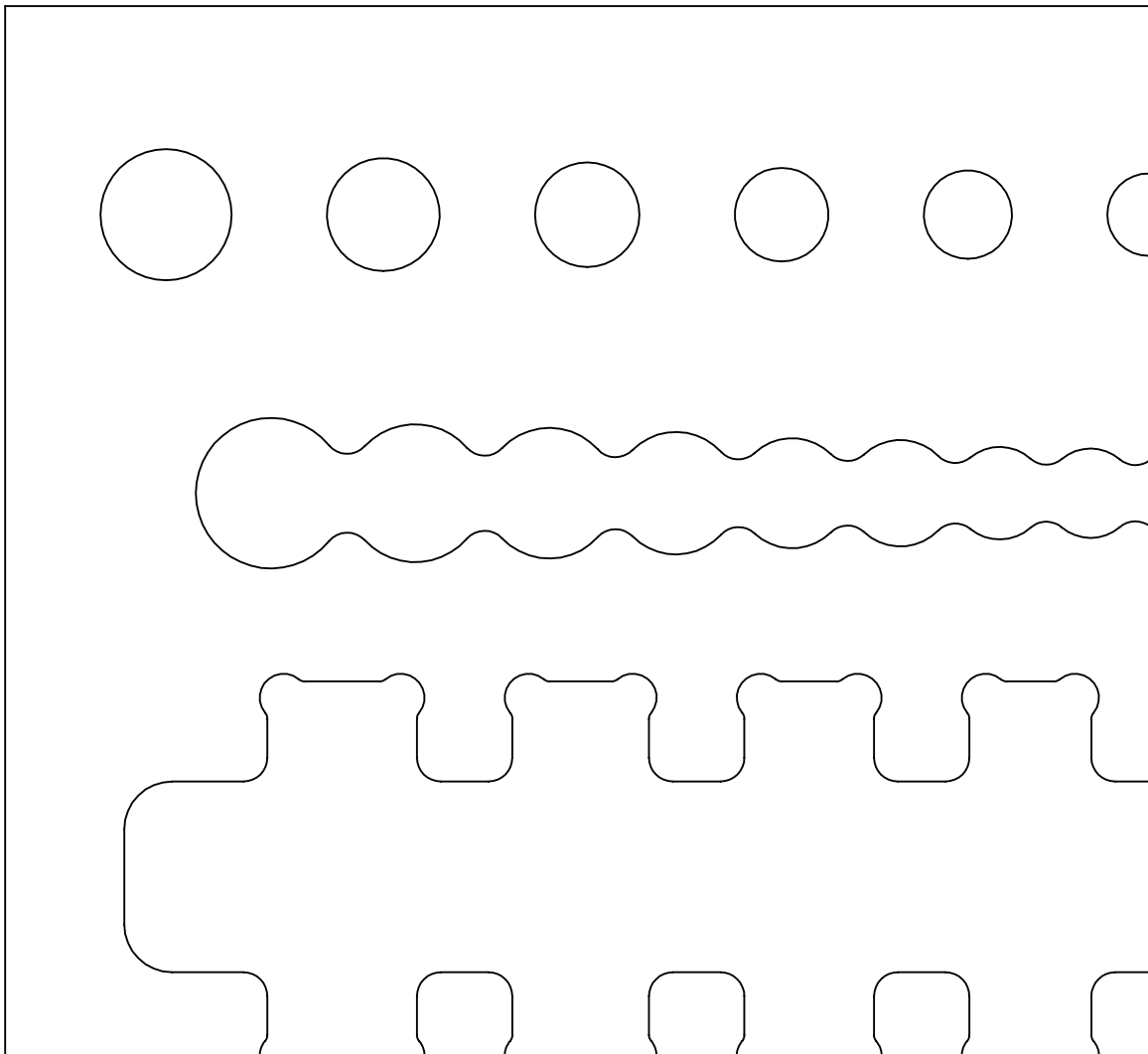

DATE CREATED

02 FEB 2016

PART NUMBER

F1M-01326

1.00 IN

PAGE KEY



1.00
IN

Print on Letter at 100%

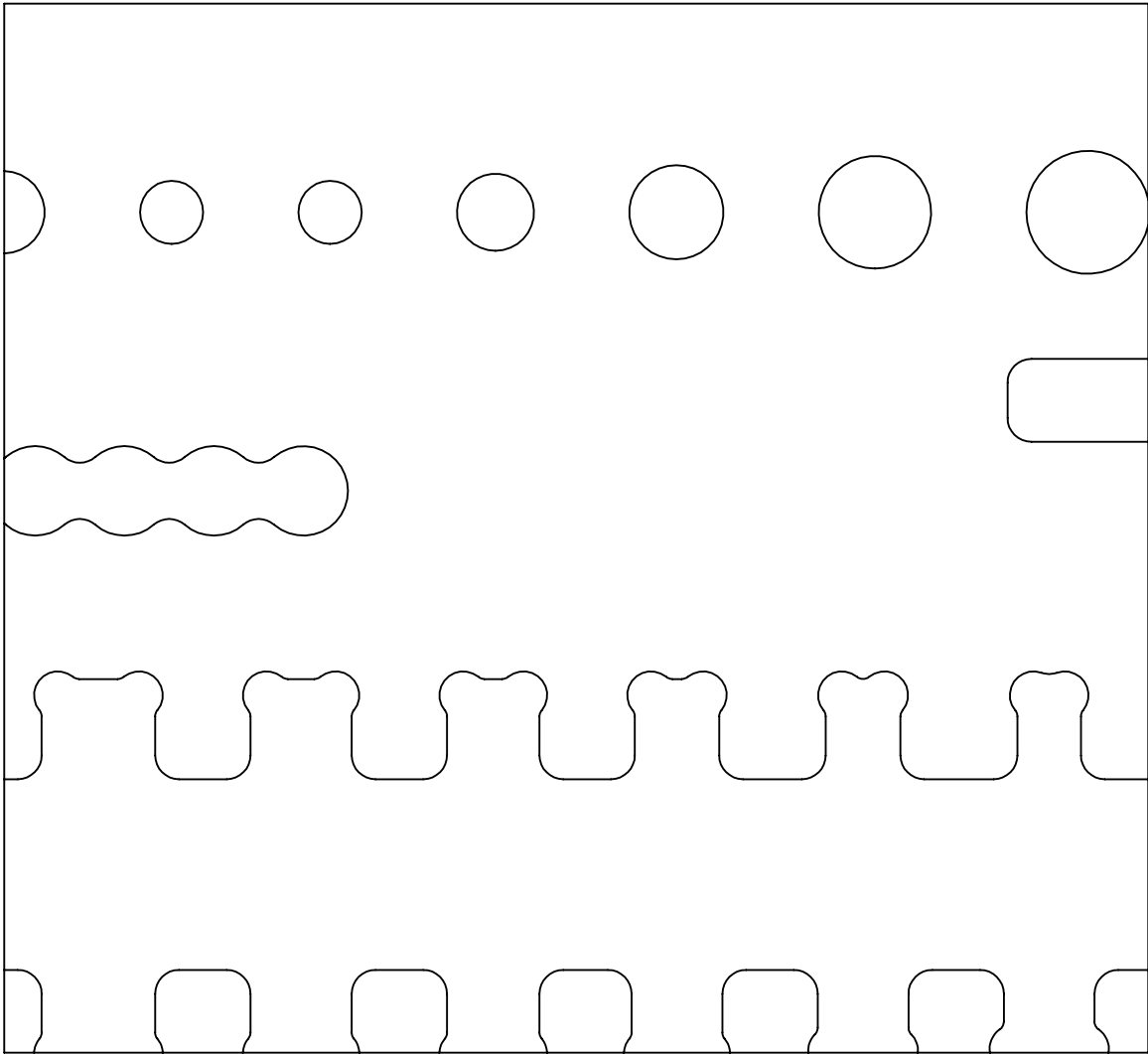

DATE CREATED

02 FEB 2016

PART NUMBER

F1M-01326

1.00 IN

PAGE KEY



1.00
IN

Print on Letter at 100%

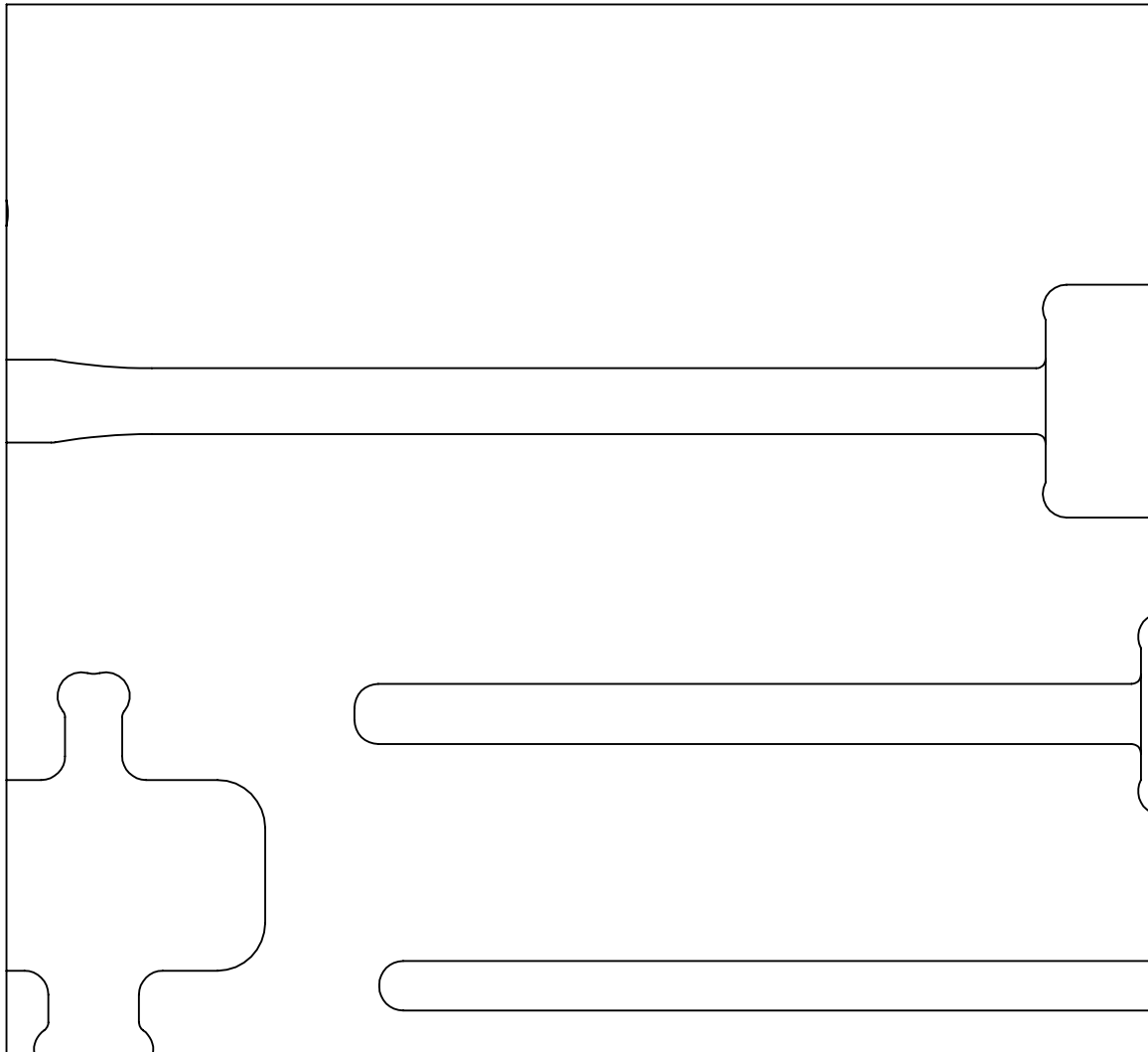

DATE CREATED

02 FEB 2016

PART NUMBER

F1M-01326

1.00 IN

PAGE KEY



1.00
IN

Print on Letter at 100%

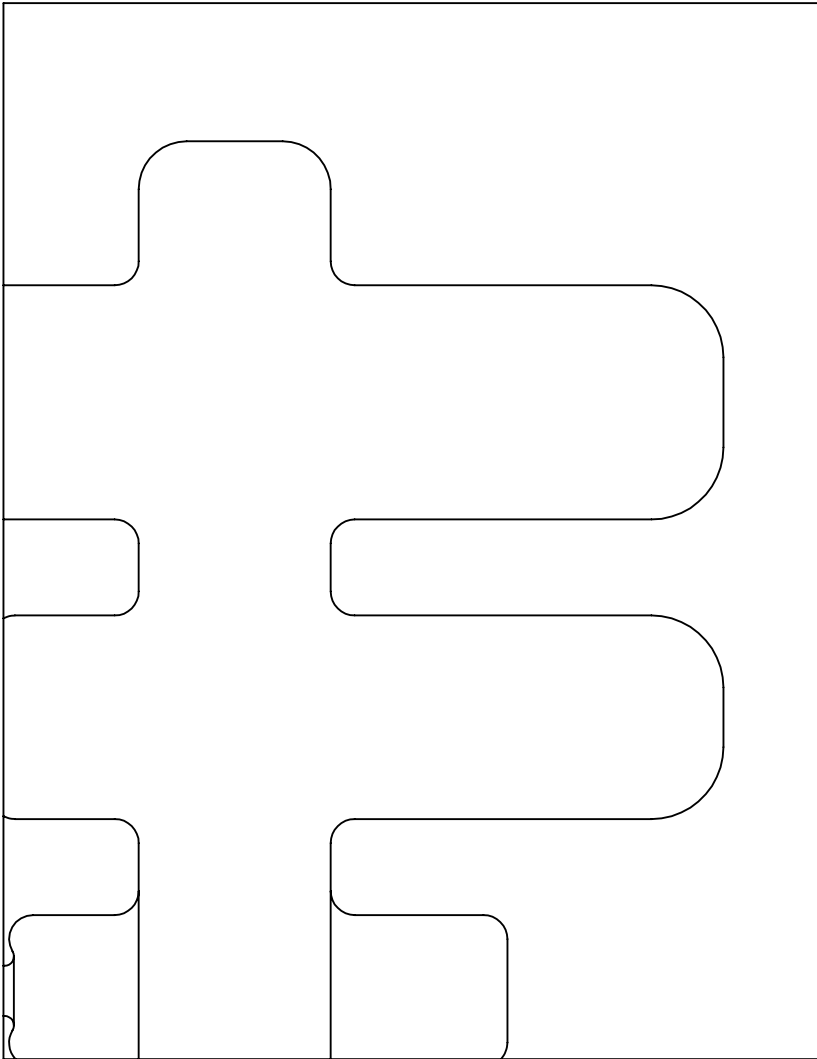

DATE CREATED

02 FEB 2016

PART NUMBER

F1M-01326