

THE INFORMATION CONTAINED ON THIS DRAWING IS THE SOLE PROPERTY OF FOAMFIT TOOLS AND MAY NOT BE USED WITHOUT PERMISSION.
Copyright 2015 FoamFit Tools

PRINTING INSTRUCTIONS

We recommend printing at full-scale to check the fit with your tools before ordering.

Option 1: Print this page full-scale on a large-format printer (D-Size, 34 inches X 22 inches).

Option 2: Print page 2 - 9 on 8-1/2 X 11 inch paper and assemble.

Thank You!

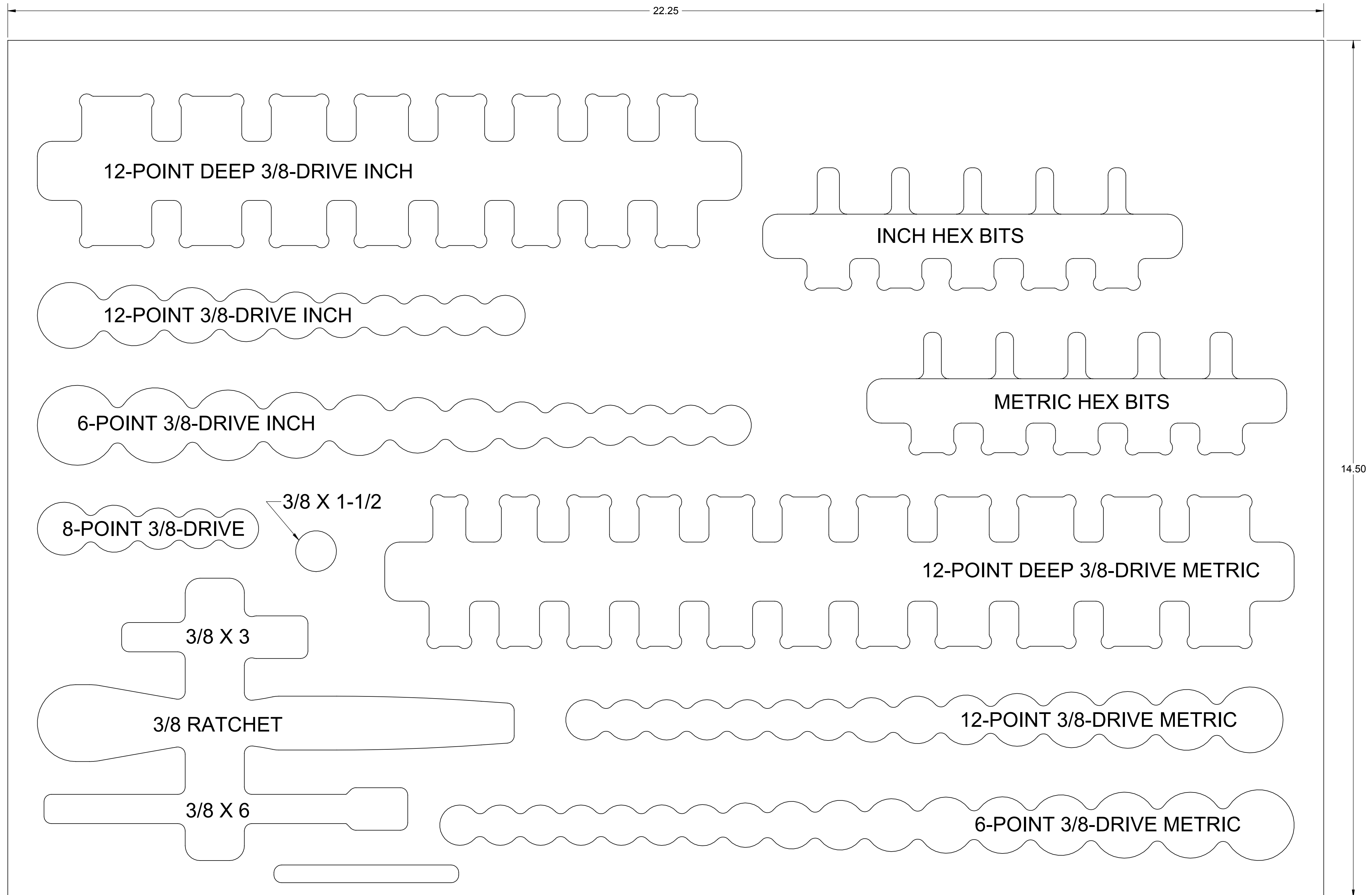
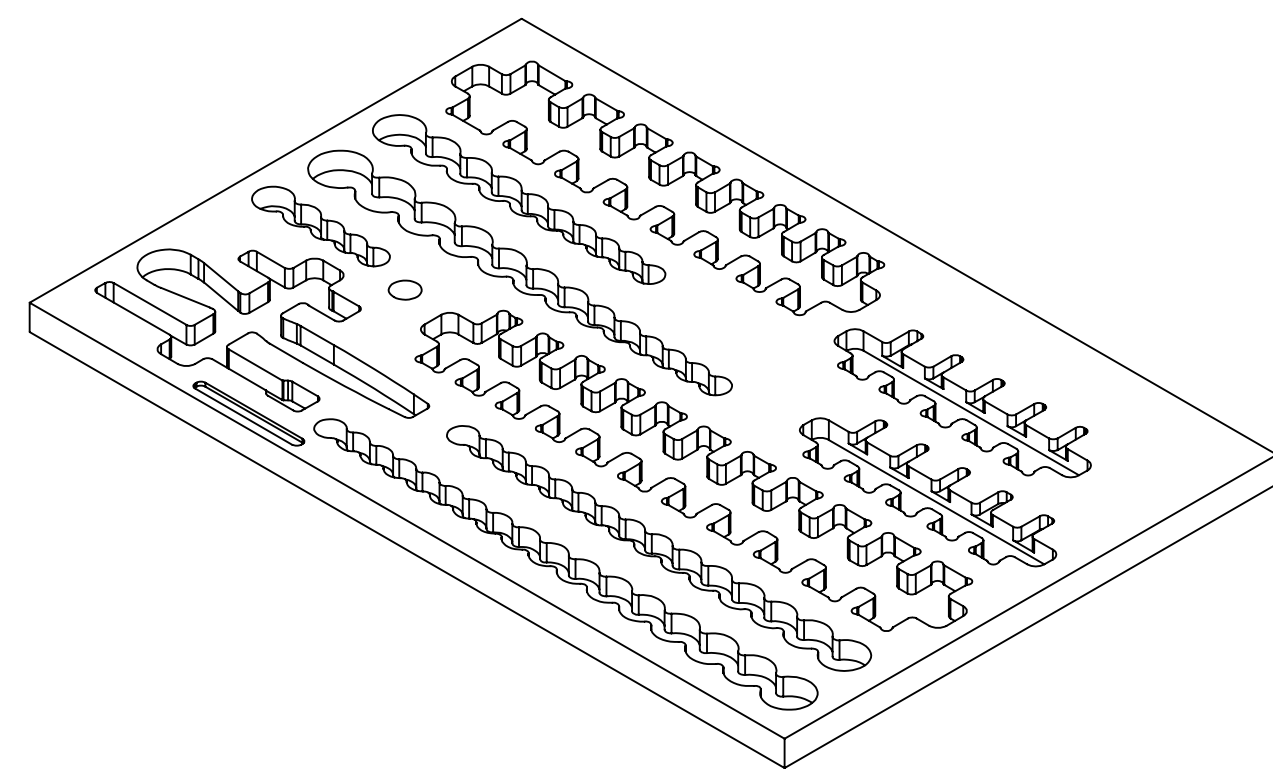

PART NUMBER
F1M-01254

1.00 IN

PAGE KEY



1.00
IN

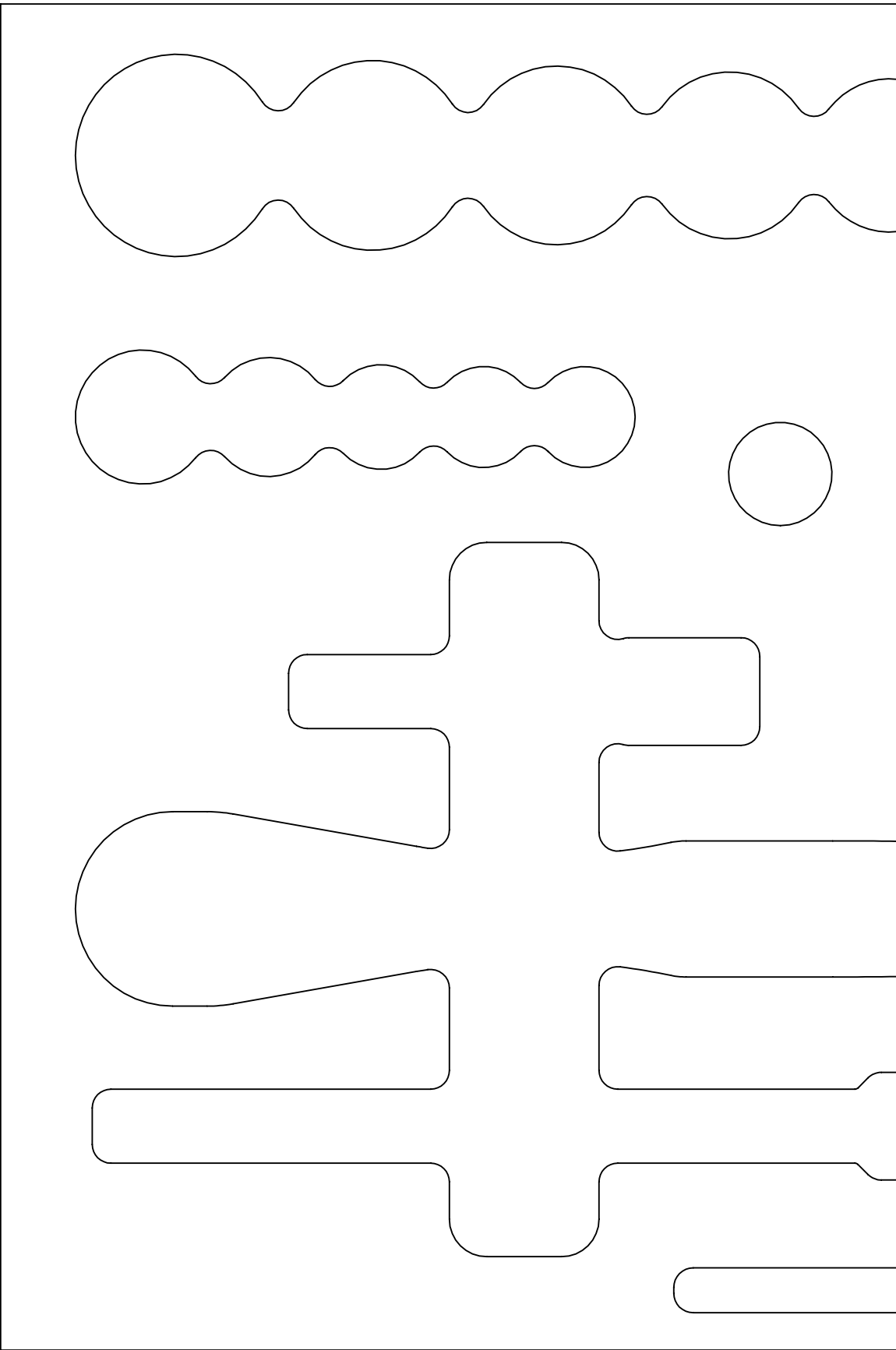

Print on Letter at 100%

DATE CREATED

04 DEC 2015

PART NUMBER

F1M-01254

1.00 IN

PAGE KEY



1.00
IN

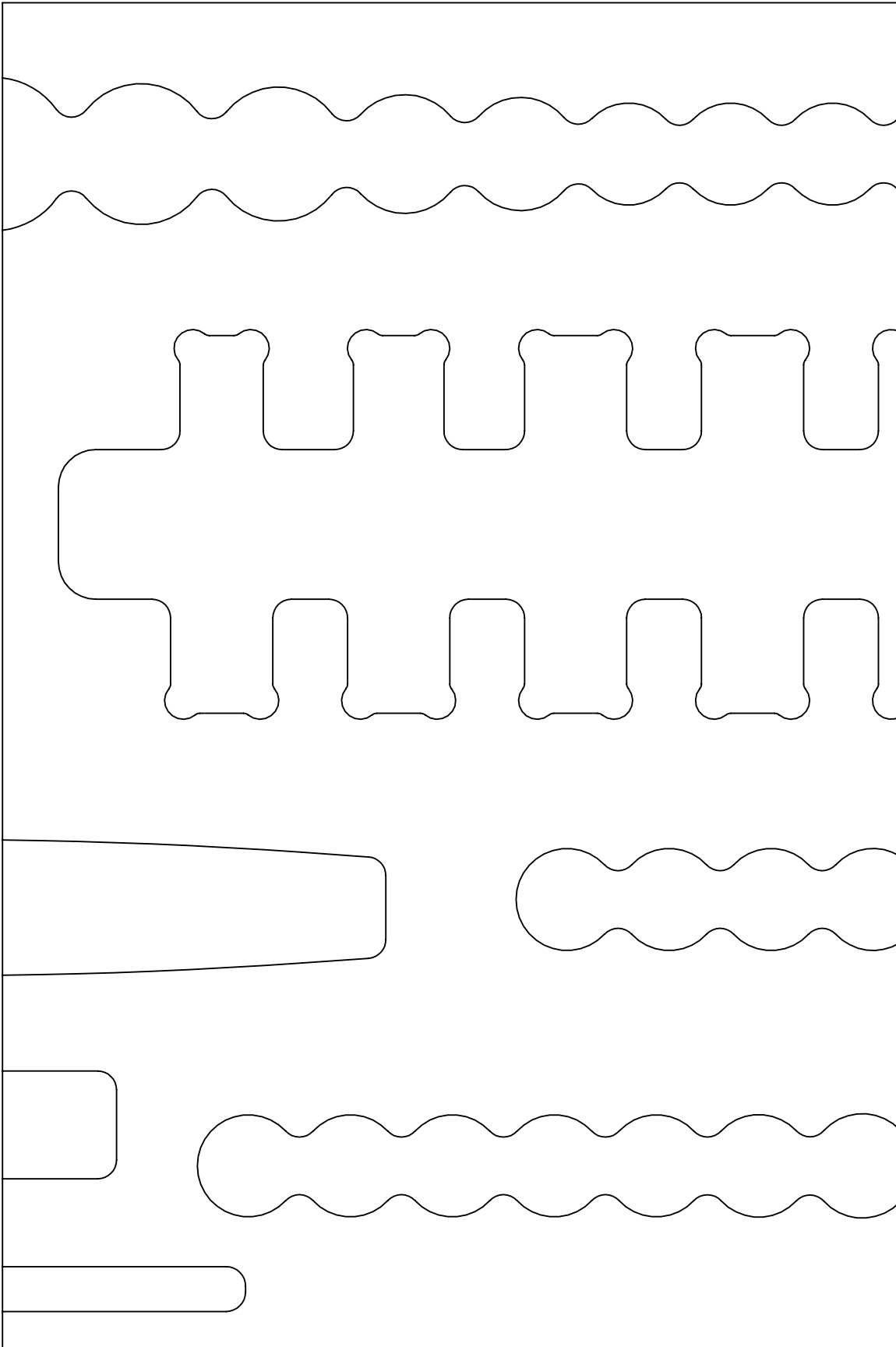

Print on Letter at 100%

DATE CREATED

04 DEC 2015

PART NUMBER

F1M-01254

1.00 IN

PAGE KEY



1.00
IN

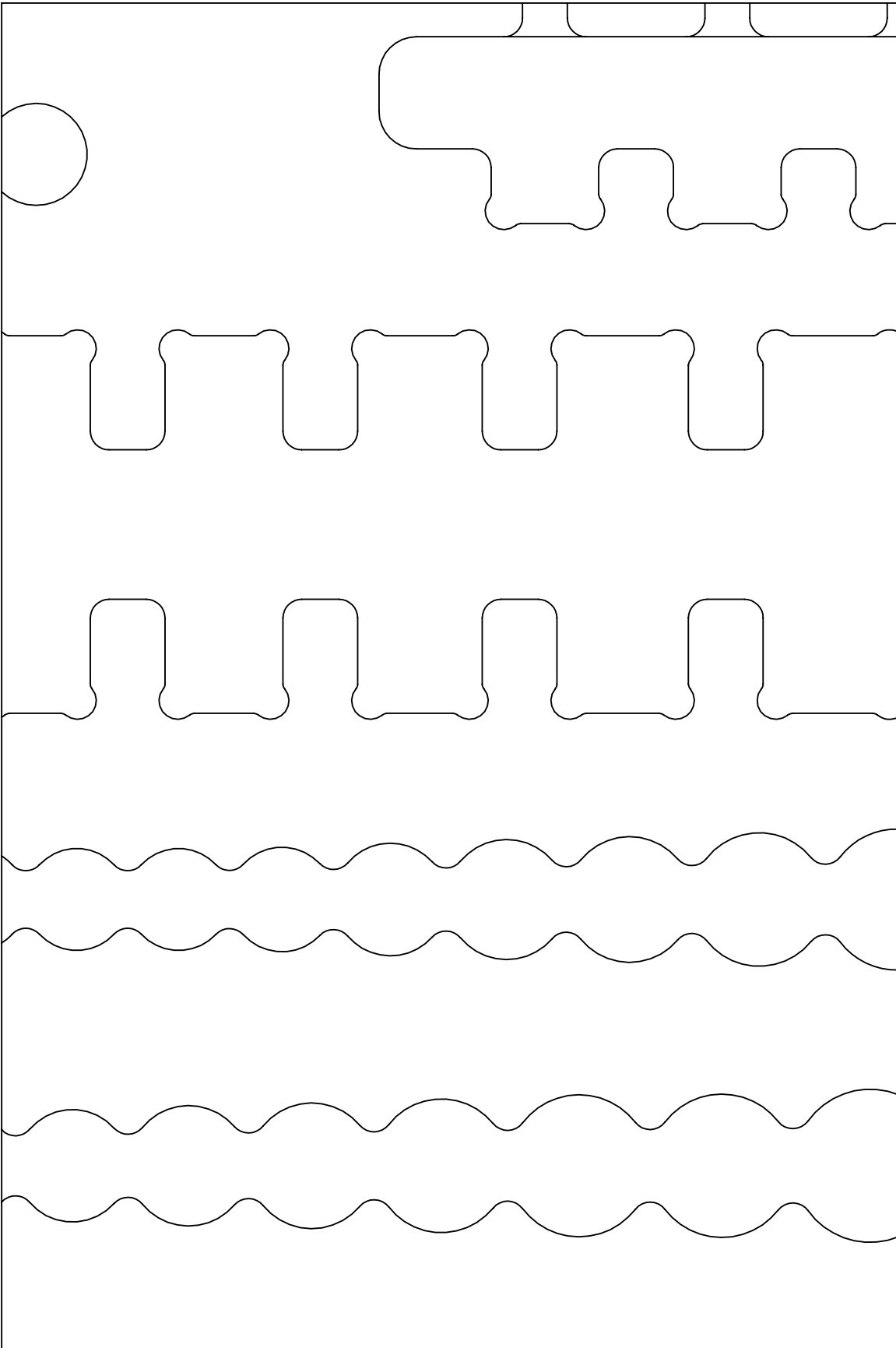

Print on Letter at 100%

DATE CREATED

04 DEC 2015

PART NUMBER

F1M-01254

← 1.00 IN →

PAGE KEY



1.00
IN

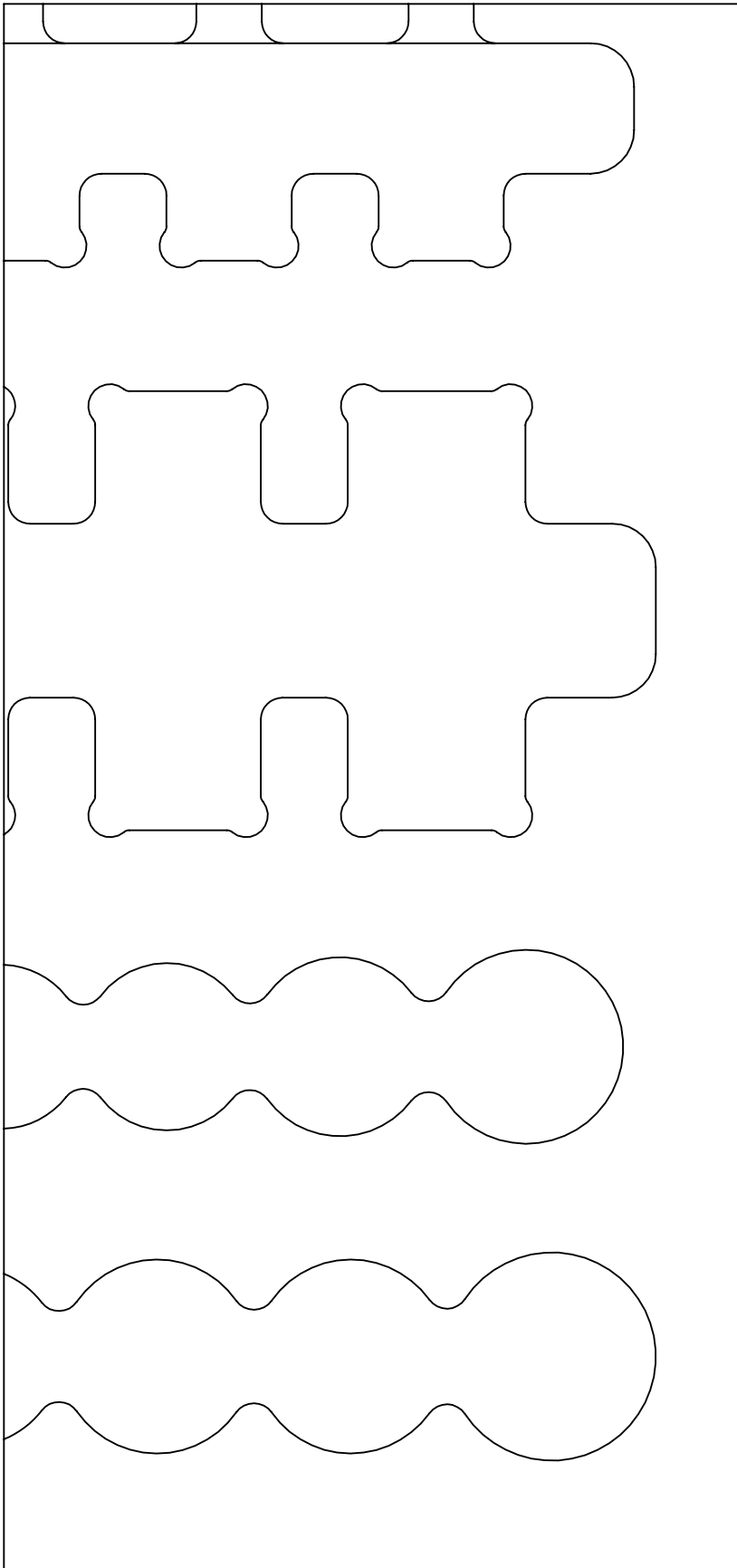

Print on Letter at 100%

DATE CREATED

04 DEC 2015

PART NUMBER

F1M-01254

1.00 IN

PAGE KEY



1.00
IN

Print on Letter at 100%

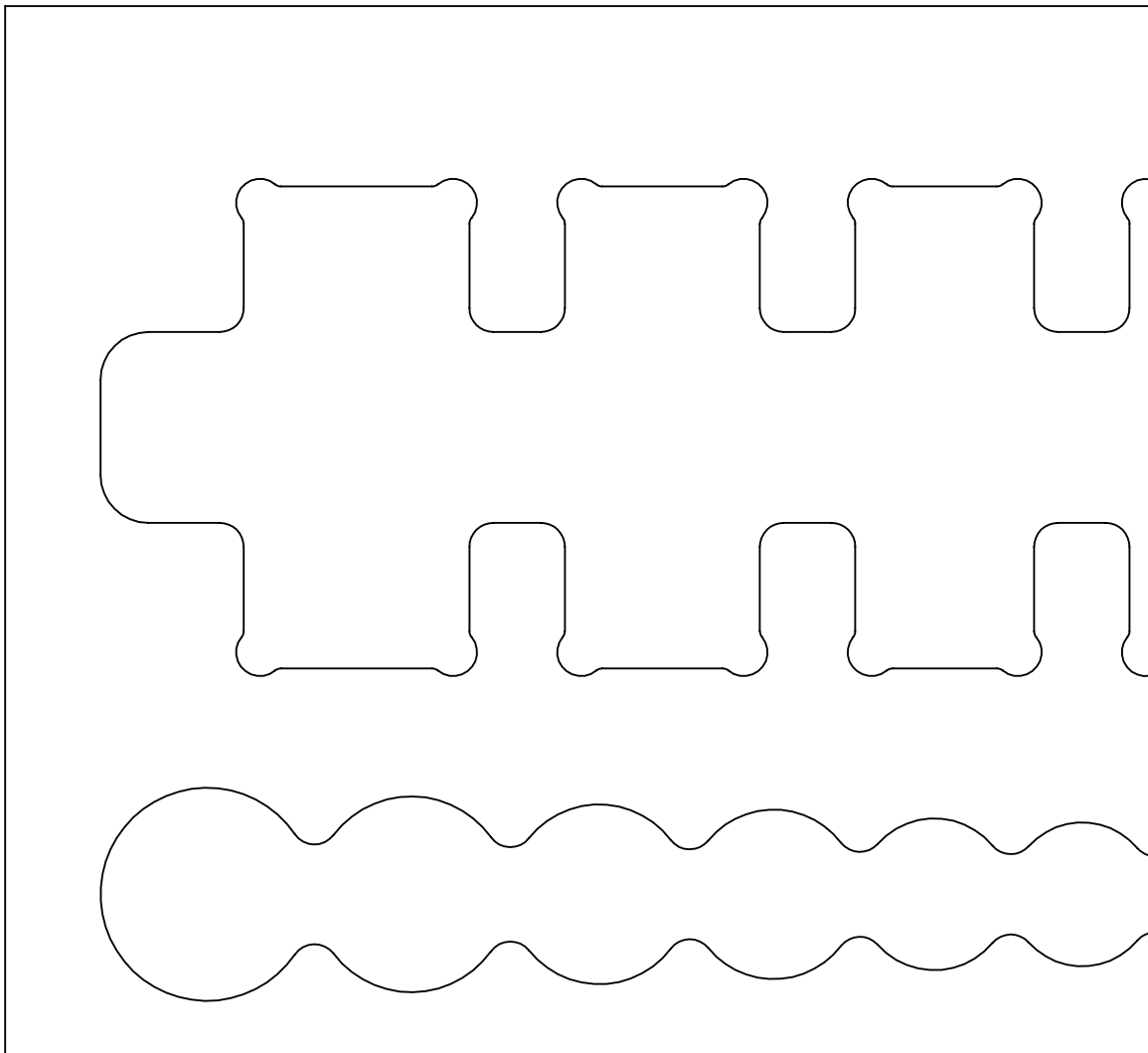

DATE CREATED

04 DEC 2015

PART NUMBER

F1M-01254

1.00 IN

PAGE KEY



1.00
IN

Print on Letter at 100%

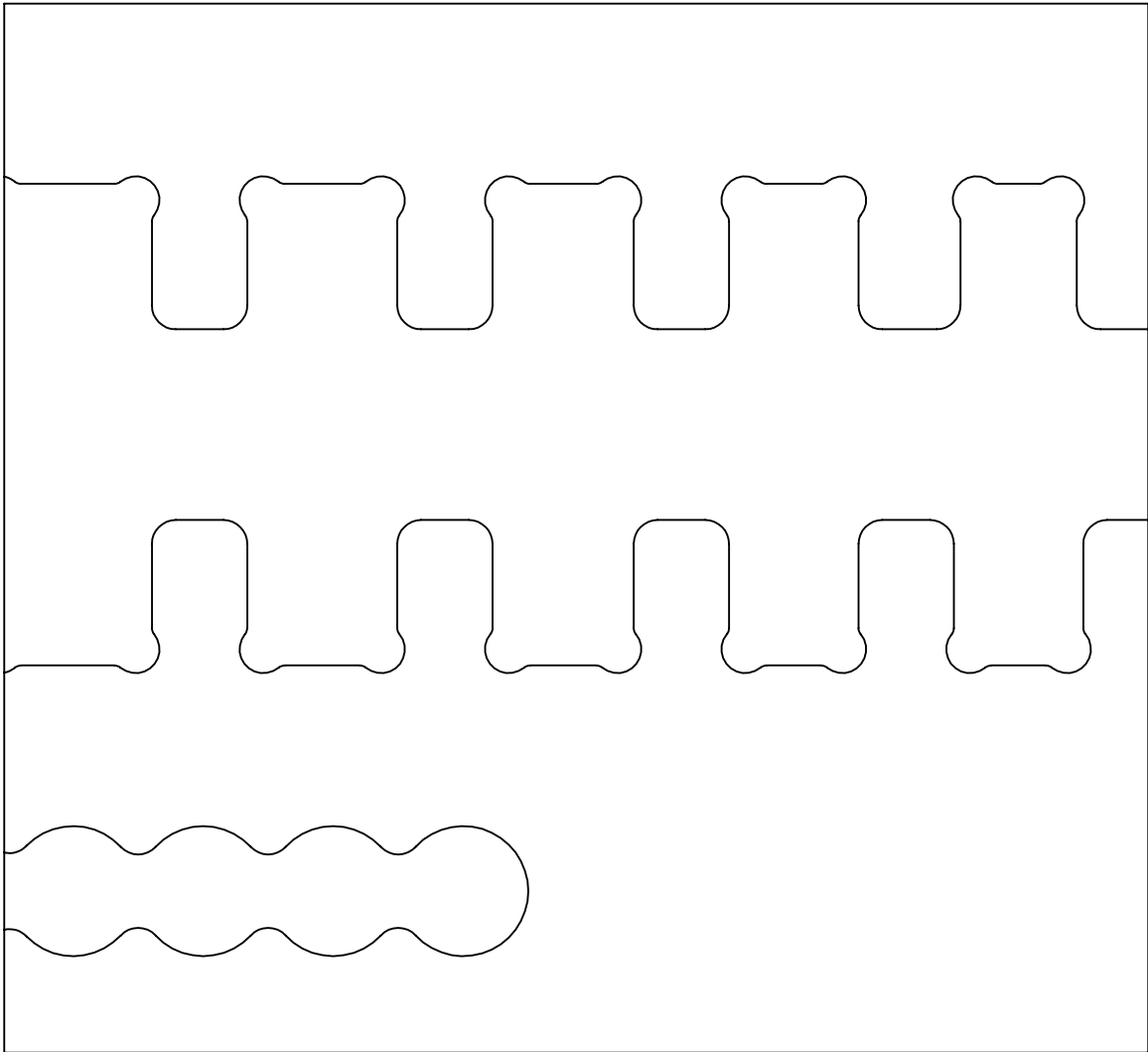

DATE CREATED

04 DEC 2015

PART NUMBER

F1M-01254

1.00 IN

PAGE KEY



1.00
IN

Print on Letter at 100%

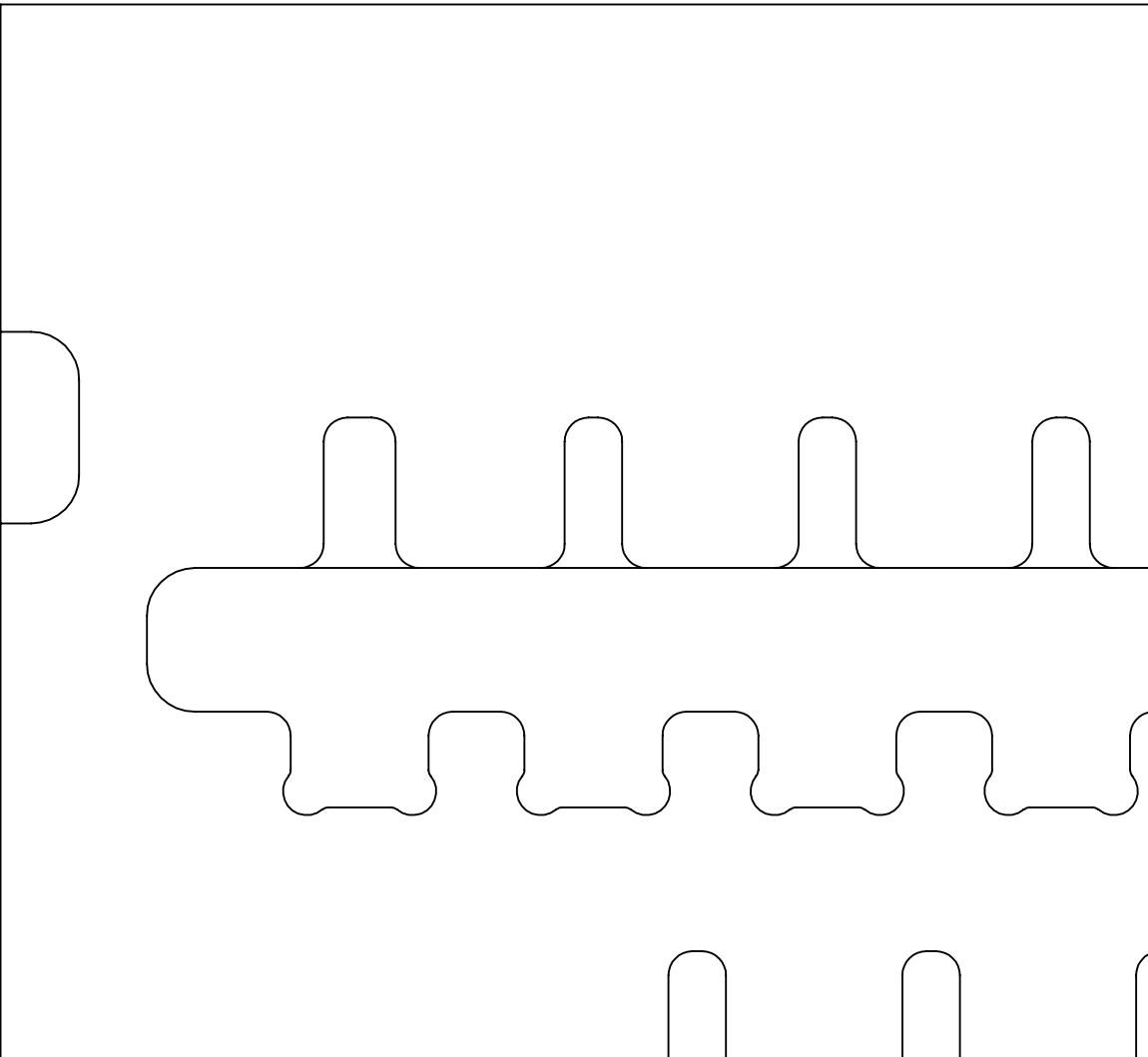

DATE CREATED

04 DEC 2015

PART NUMBER

F1M-01254

1.00 IN

PAGE KEY



1.00
IN

Print on Letter at 100%

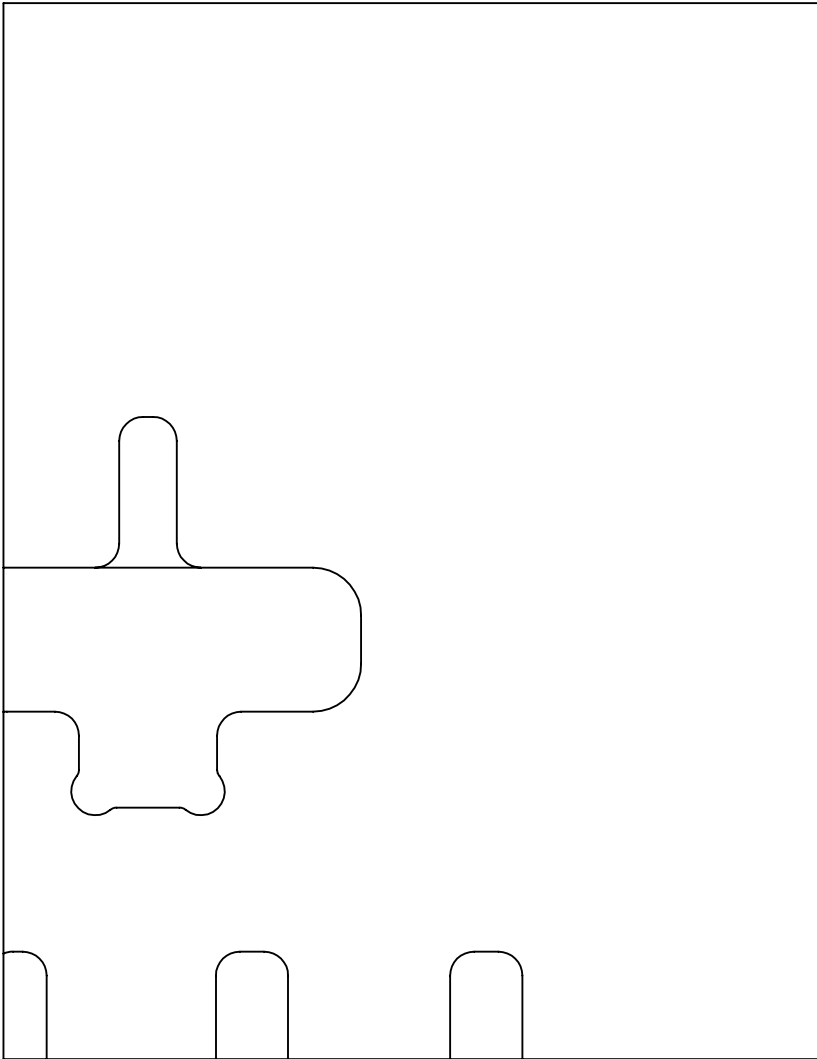

DATE CREATED

04 DEC 2015

PART NUMBER

F1M-01254