

**PRINTING INSTRUCTIONS**

We recommend printing at full-scale to check the fit with your tools before ordering.

**Option 1:** Print this page full-scale on a large-format printer (E-Size, 44 inches X 34 inches).

**Option 2:** Print page 2 - 9 on 8-1/2 X 11 inch paper and assemble.

**Thank You!**

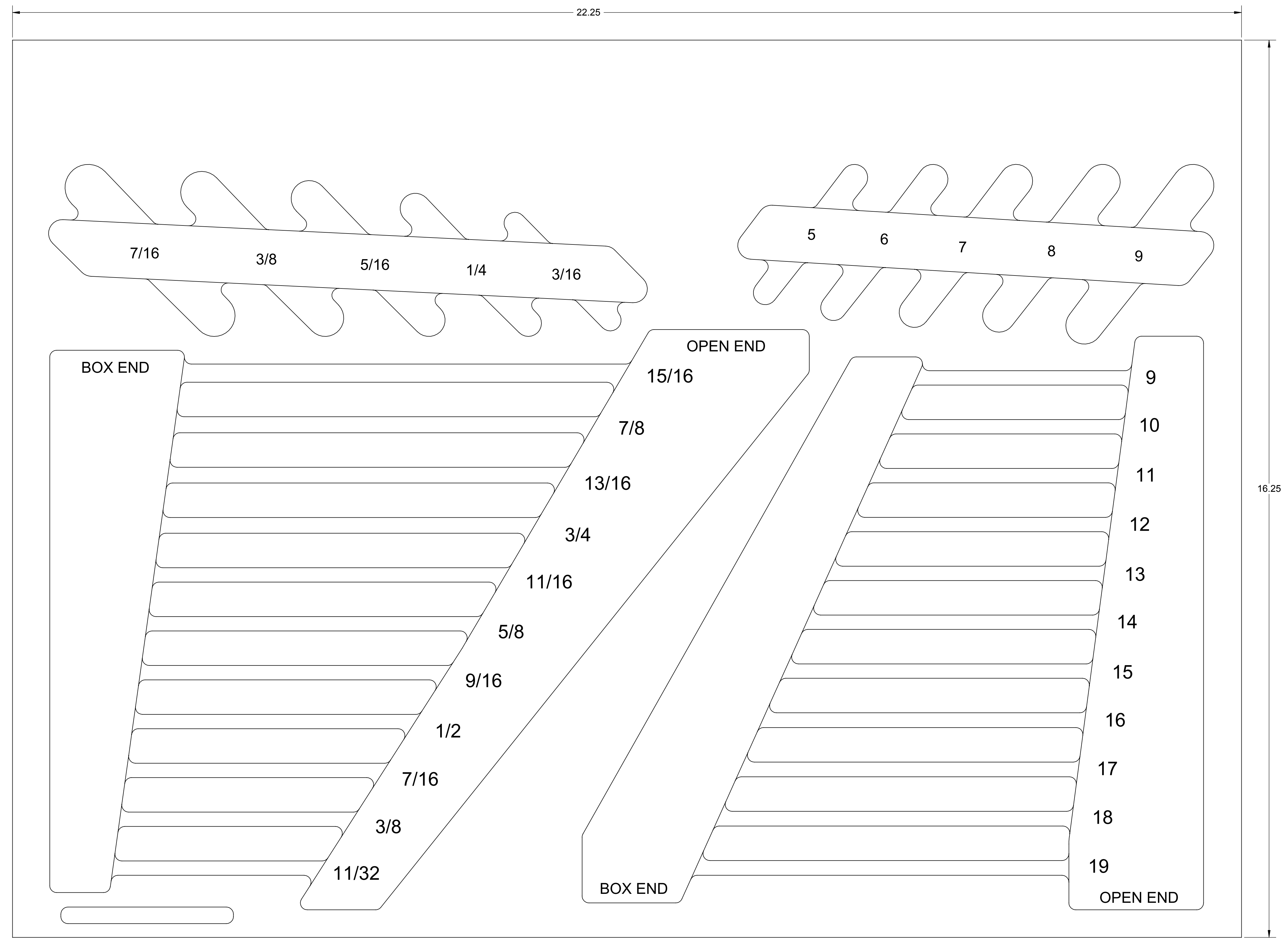
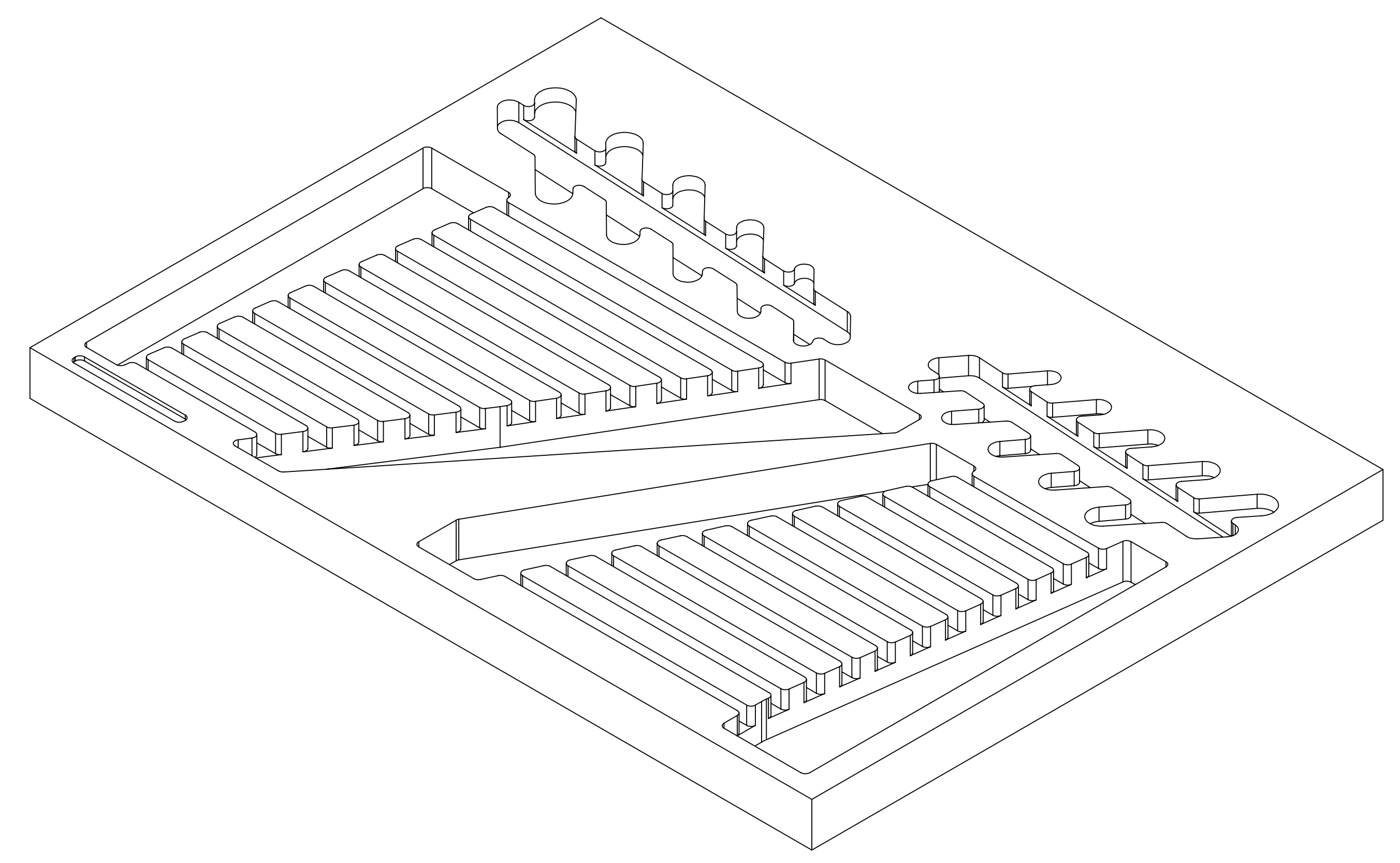

**CAUTION  
RECOMMENDED FOR A  
3-INCH DRAWER HEIGHT**

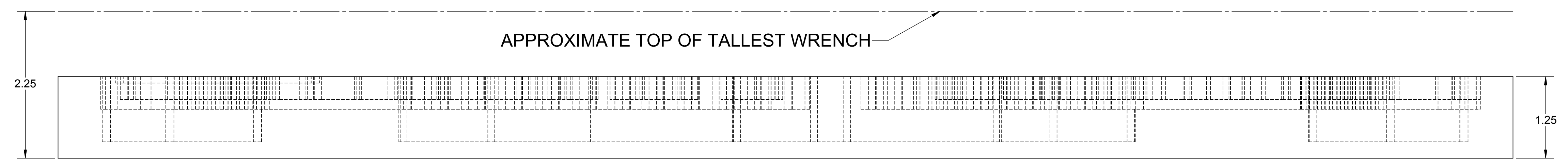

PART NUMBER **F1A-01593**

Print on Letter at 100%

1.00  
IN

1.00 IN

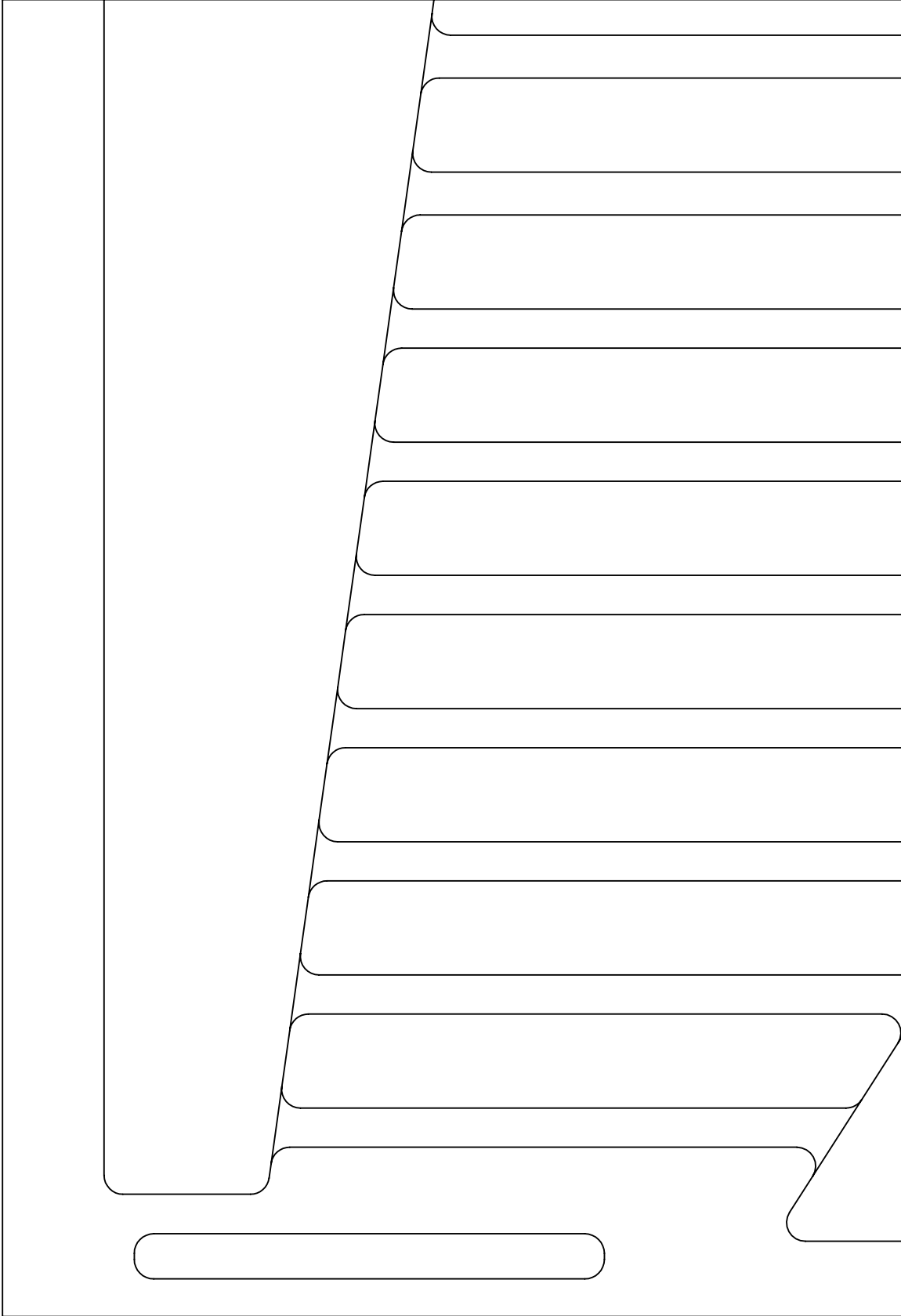

PAGE KEY

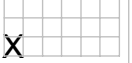

DATE CREATED

**13 SEP 2016**

PART NUMBER

**F1A-01593**

← 1.00 IN →

PAGE KEY

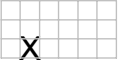

1.00  
IN

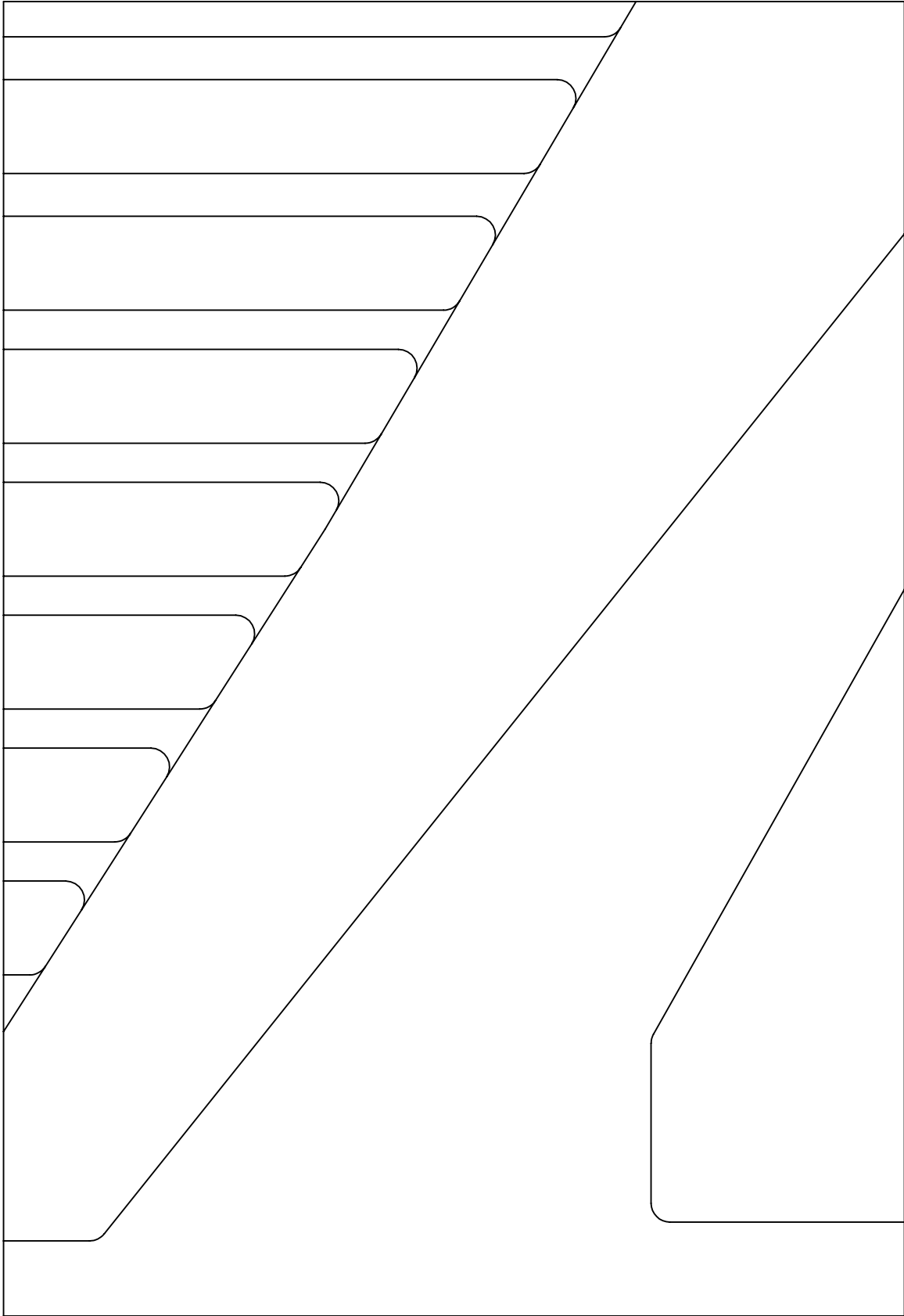

Print on Letter at 100%

DATE CREATED

**13 SEP 2016**

PART NUMBER

**F1A-01593**

1.00 IN

PAGE KEY



1.00  
IN

Print on Letter at 100%

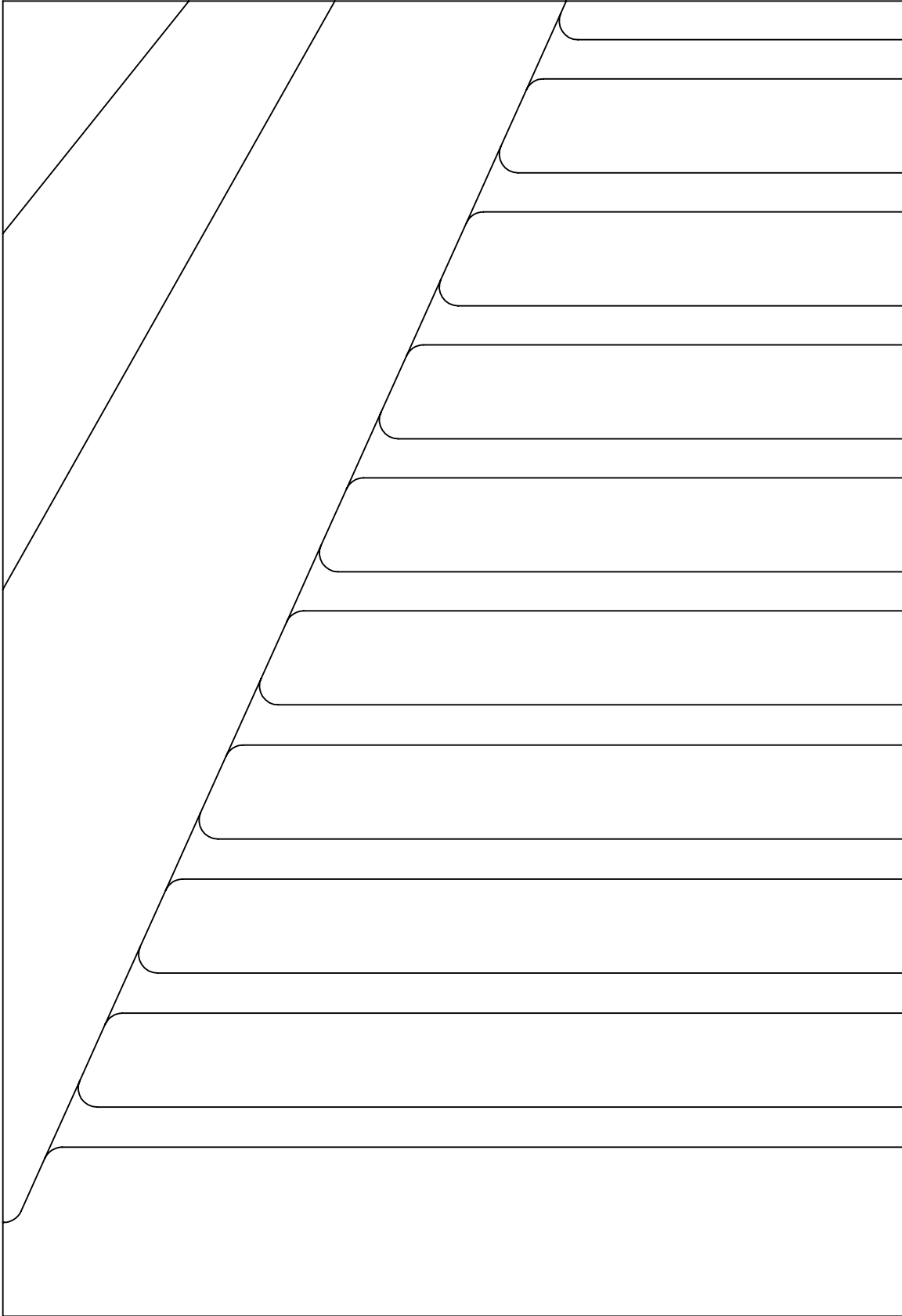

DATE CREATED

**13 SEP 2016**

PART NUMBER

**F1A-01593**

Print on Letter at 100%

← 1.00 IN →

1.00  
IN

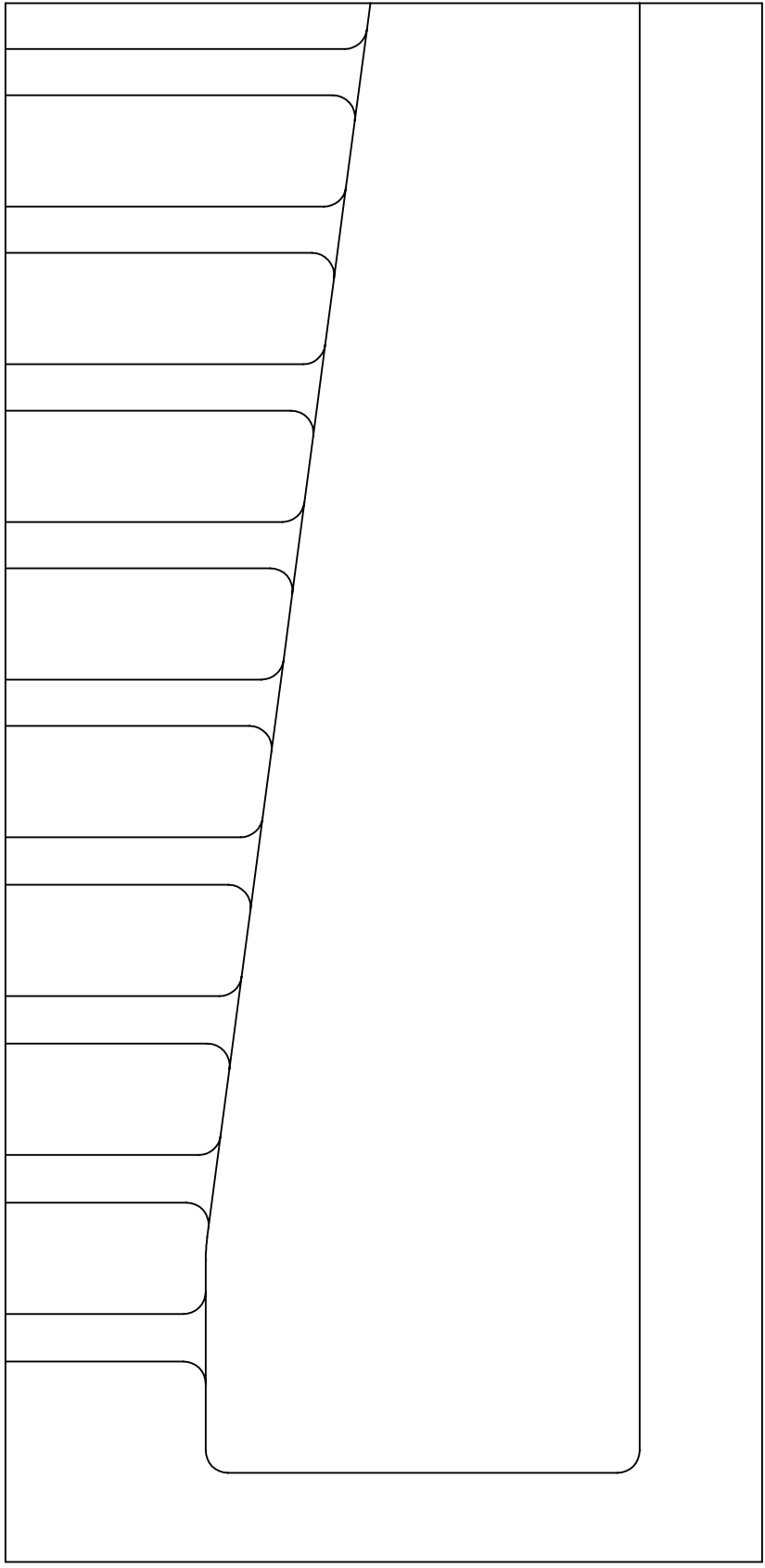

PAGE KEY

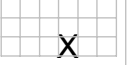

DATE CREATED

**13 SEP 2016**

PART NUMBER

**F1A-01593**

1.00 IN

PAGE KEY

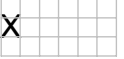

1.00  
IN

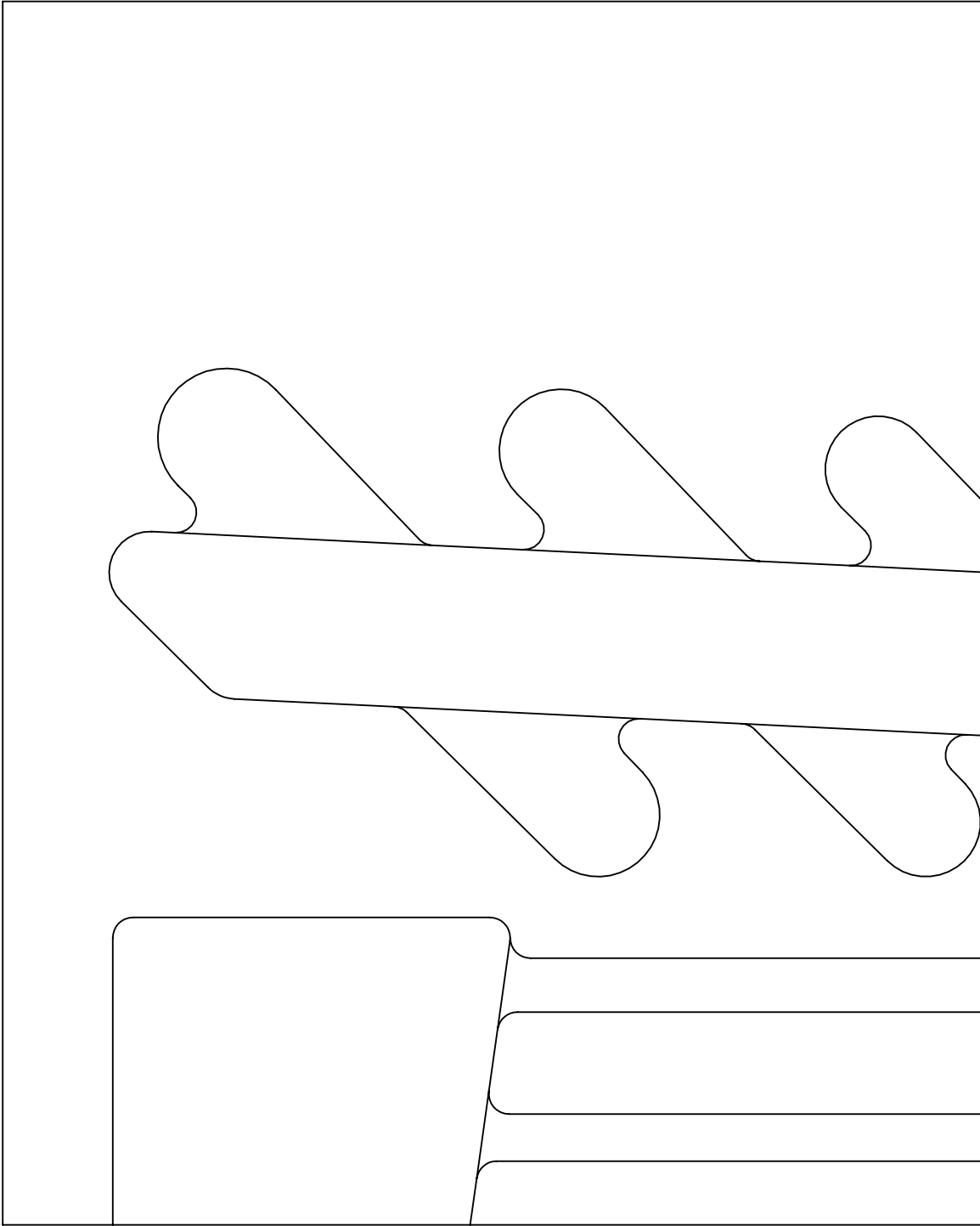

Print on Letter at 100%

DATE CREATED

**13 SEP 2016**

PART NUMBER

**F1A-01593**

1.00 IN

PAGE KEY

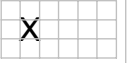

1.00  
IN

Print on Letter at 100%

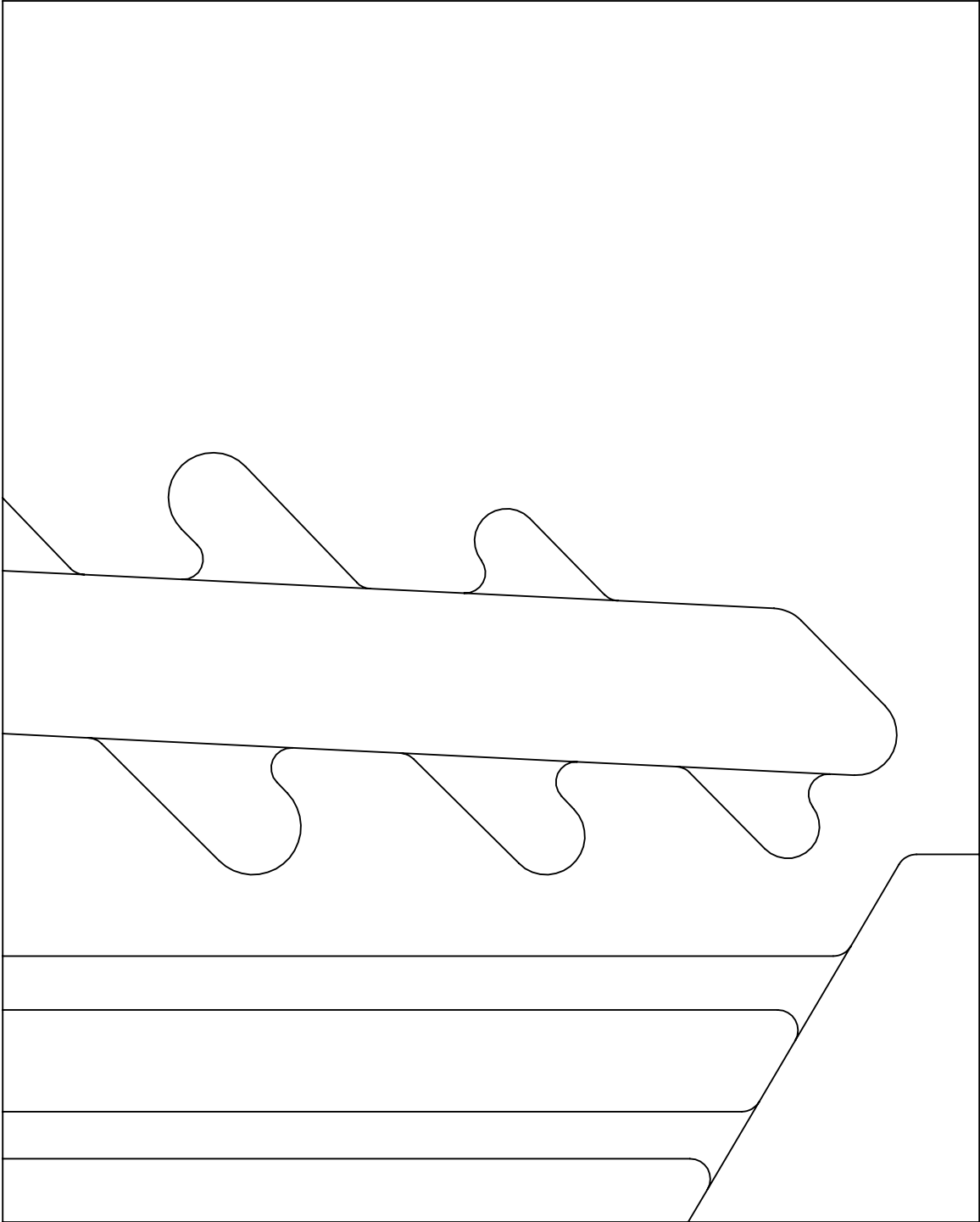

DATE CREATED

**13 SEP 2016**

PART NUMBER

**F1A-01593**

1.00 IN

PAGE KEY

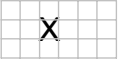

1.00  
IN

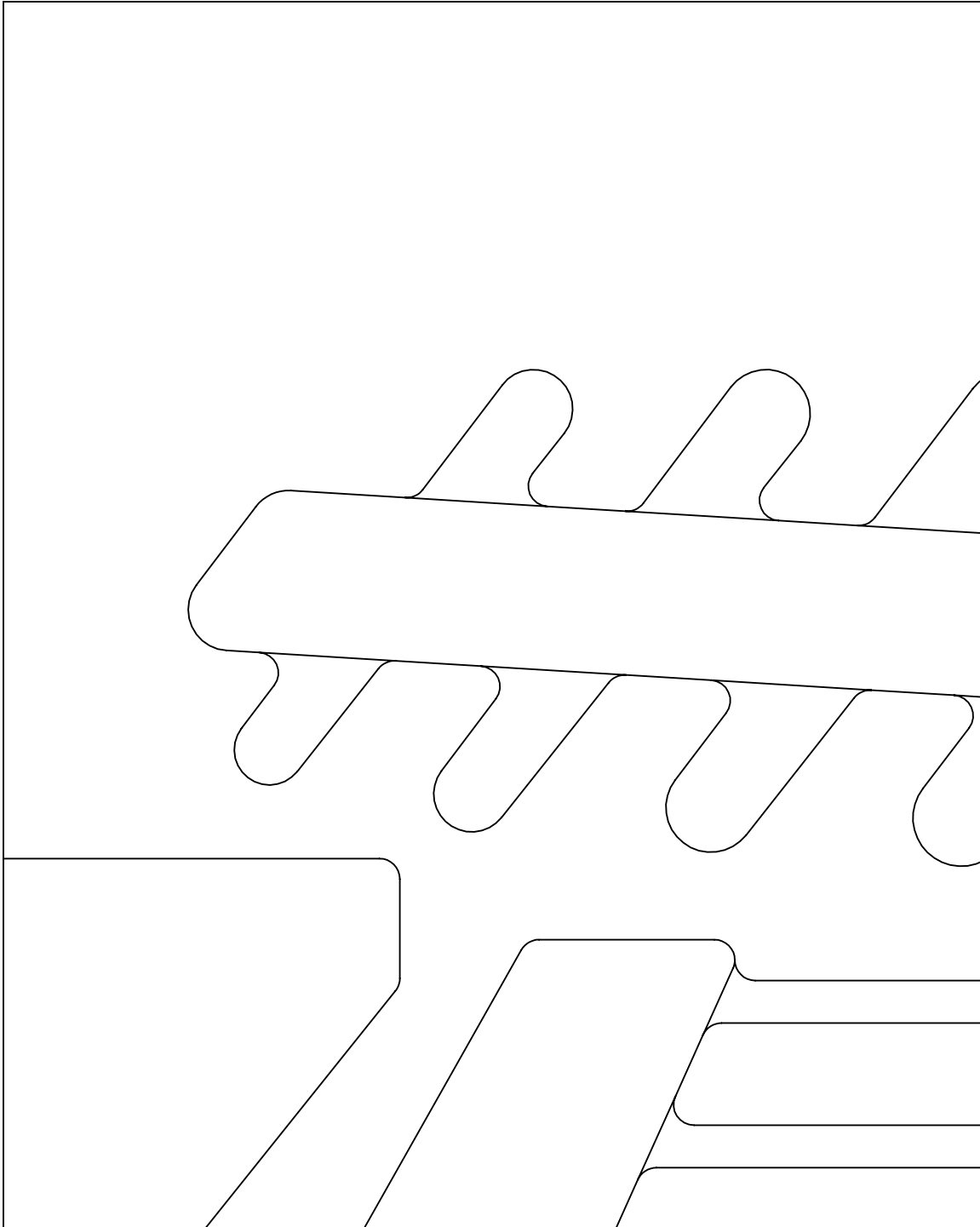

Print on Letter at 100%

DATE CREATED

**13 SEP 2016**

PART NUMBER

**F1A-01593**



1.00 IN

PAGE KEY



1.00  
IN

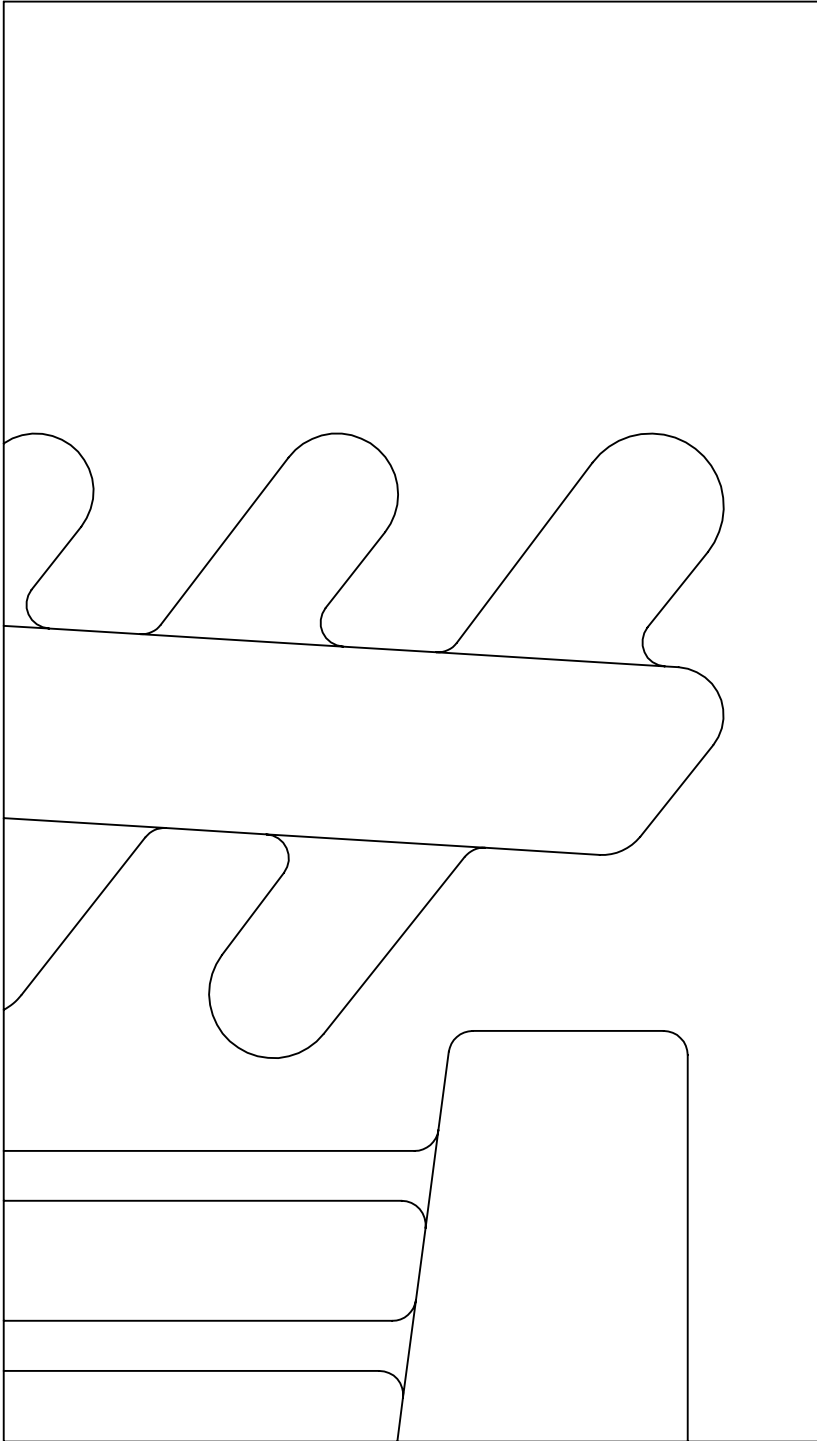

Print on Letter at 100%

DATE CREATED

**13 SEP 2016**

PART NUMBER

**F1A-01593**