

PRINTING INSTRUCTIONS

We recommend printing at full-scale to check the fit with your tools before ordering.

Option 1: Print this page full-scale on a large-format printer (E-Size, 44 inches X 34 inches).

Option 2: Print page 2 - 9 on 8-1/2 X 11 inch paper and assemble.

Thank You!

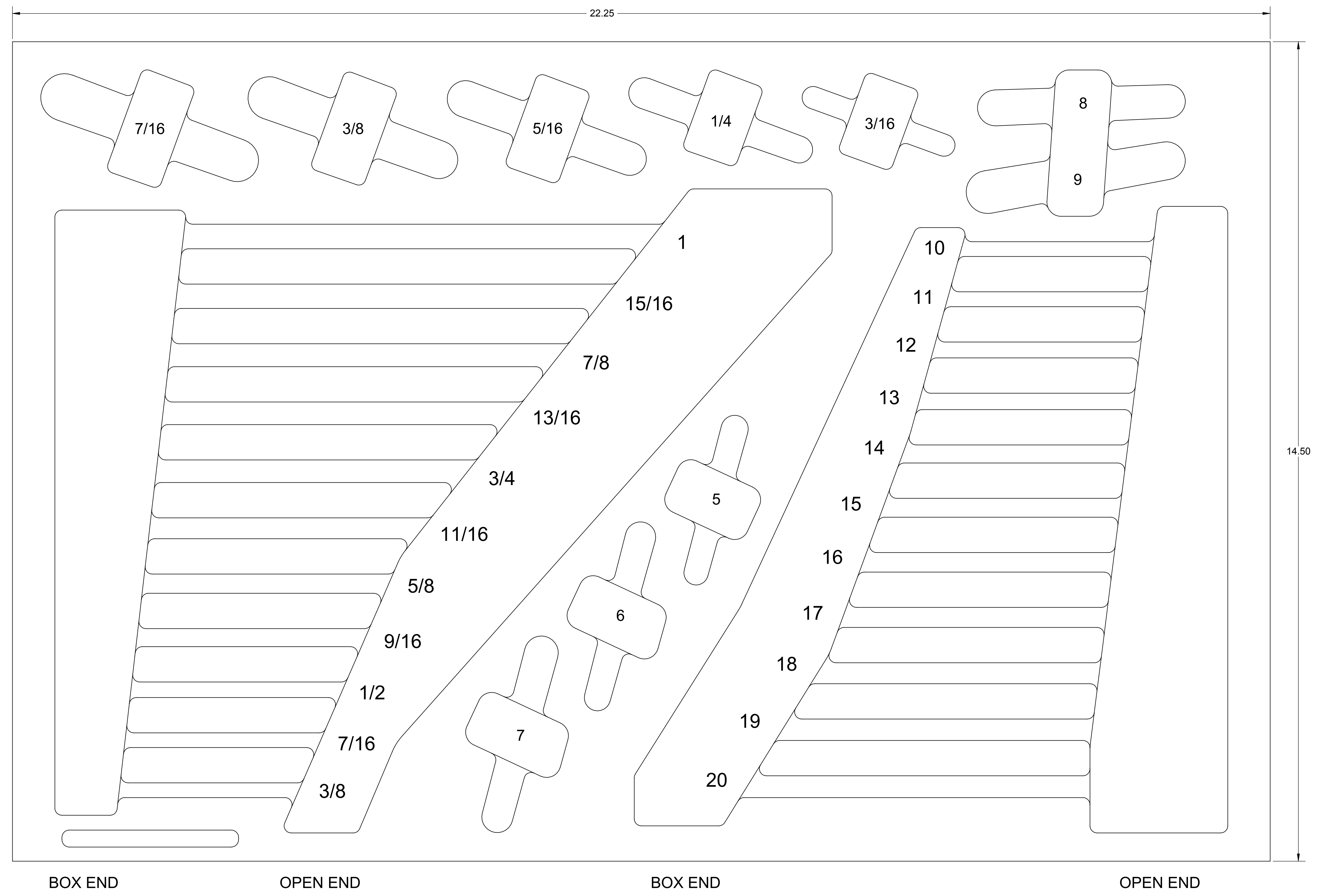
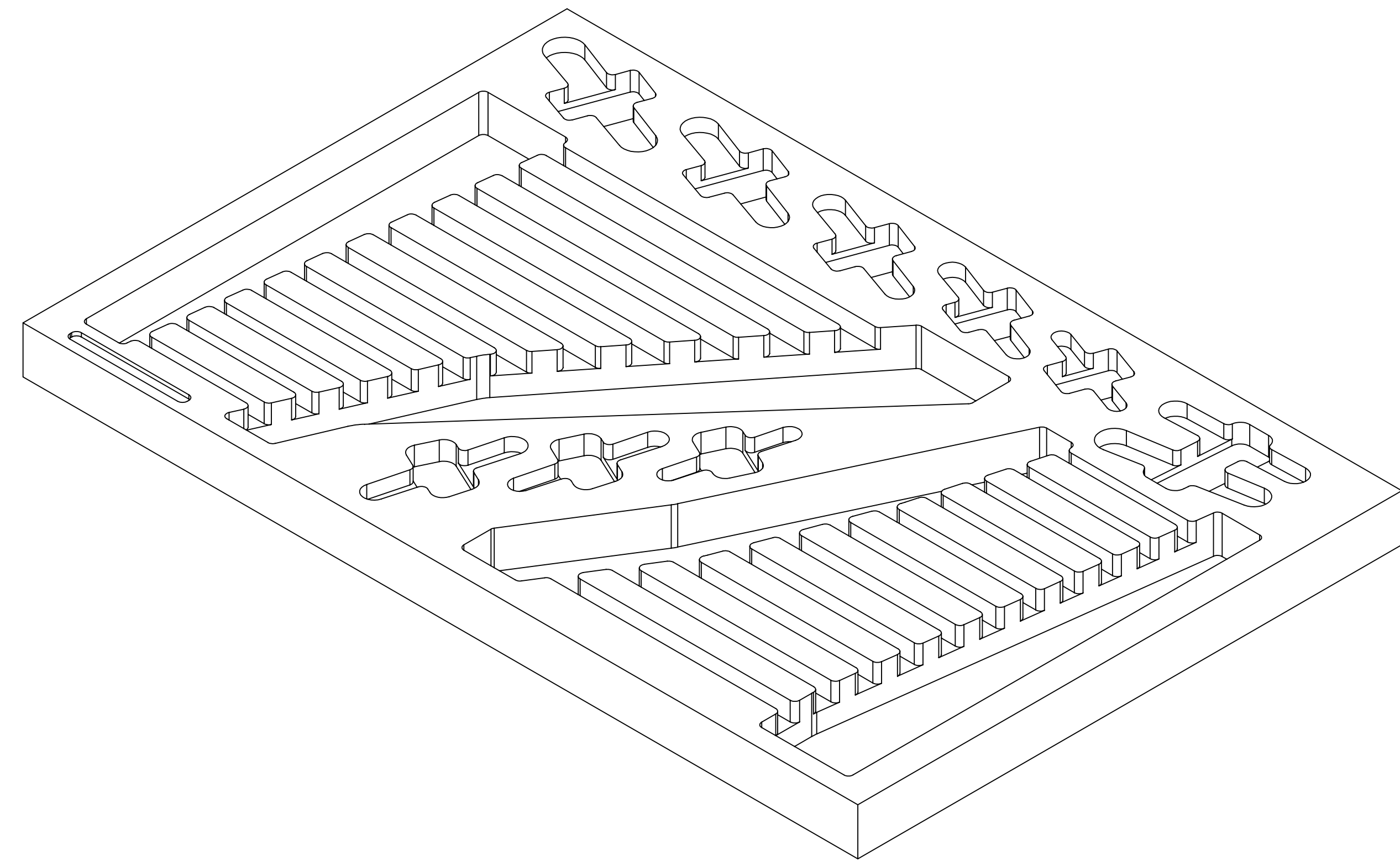

PART NUMBER **F1A-01153**

**CAUTION
RECOMMENDED FOR A
3-INCH DRAWER HEIGHT**

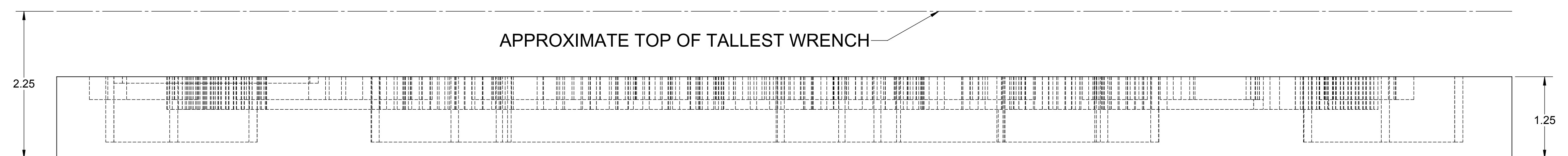

← 1.00 IN →

PAGE KEY

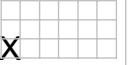

↑ 1.00 IN ↓

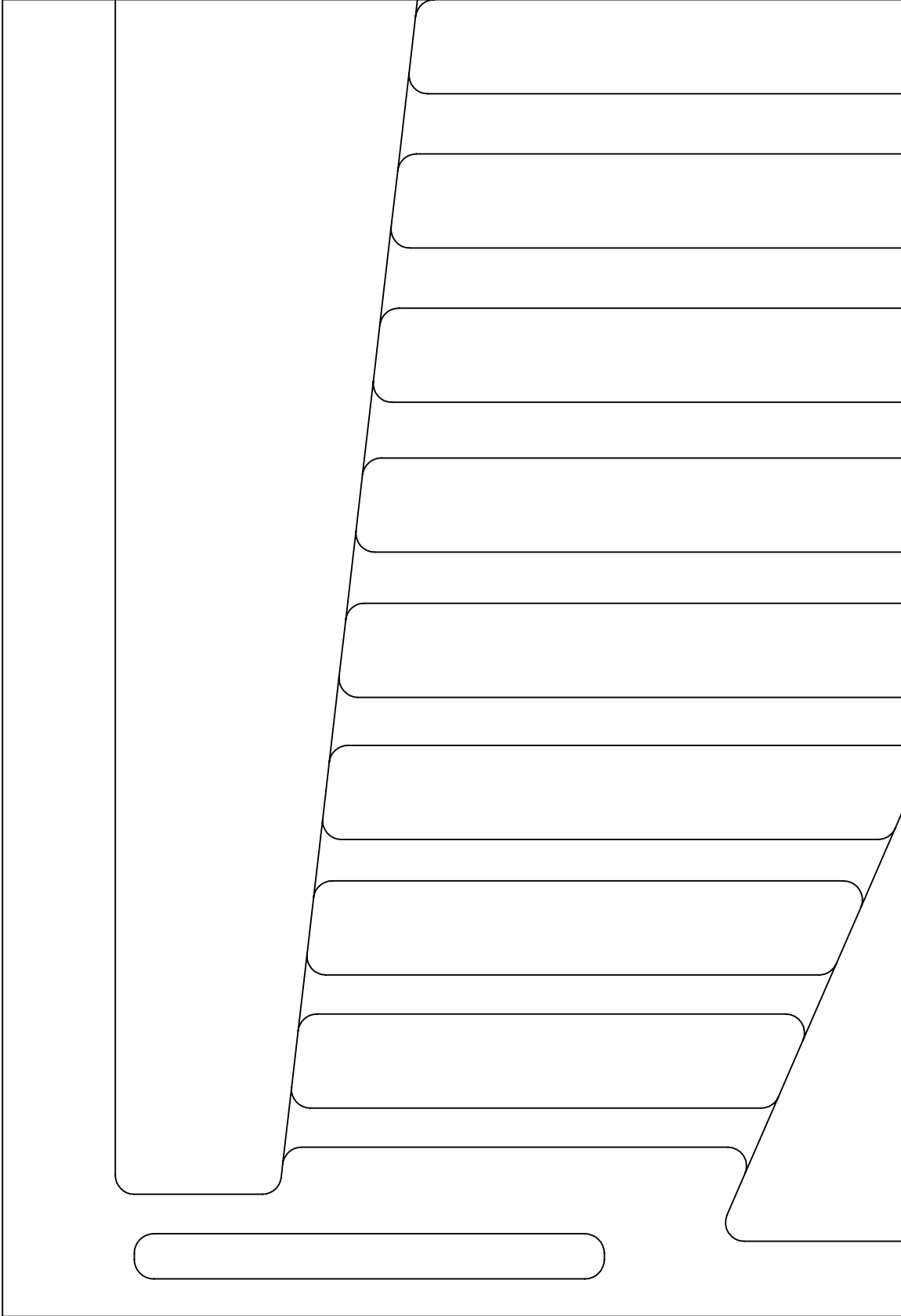

Print on Letter at 100%

DATE CREATED

03 SEP 2015

PART NUMBER

F1A-01153

1.00 IN

PAGE KEY

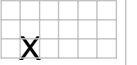

1.00
IN

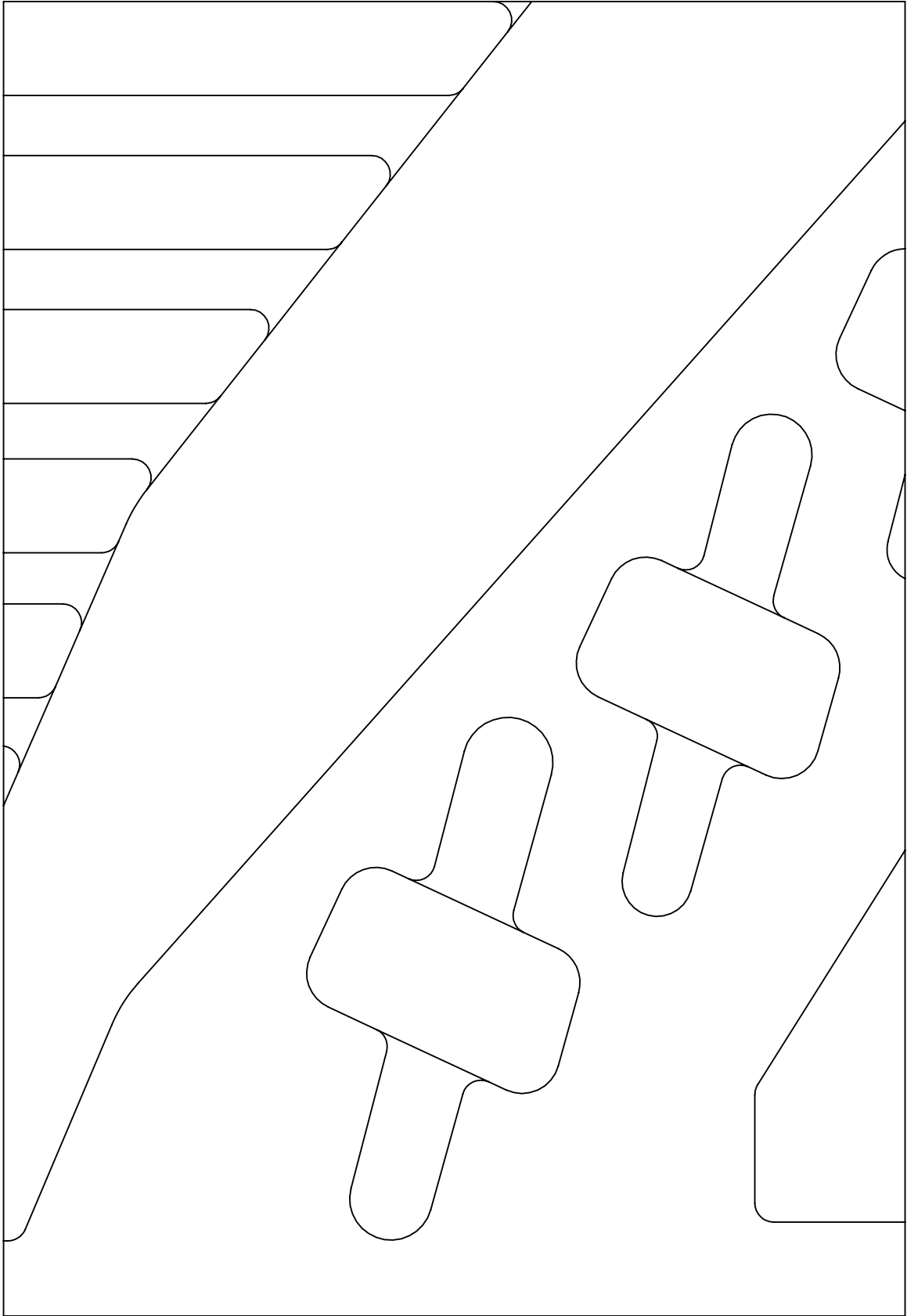

Print on Letter at 100%

DATE CREATED

03 SEP 2015

PART NUMBER

F1A-01153

1.00 IN

PAGE KEY



1.00 IN

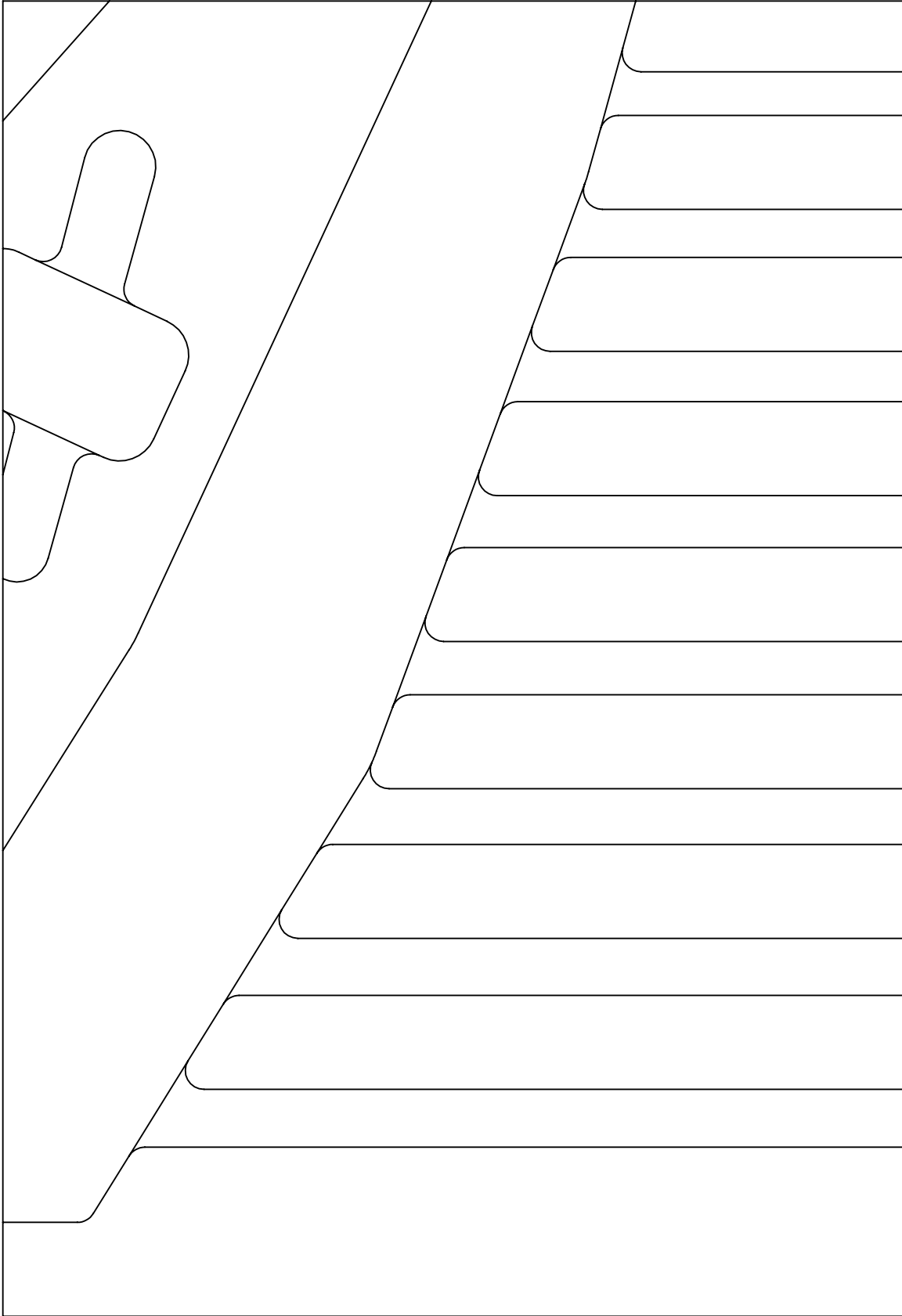

Print on Letter at 100%

DATE CREATED

03 SEP 2015

PART NUMBER

F1A-01153

Print on Letter at 100%

← 1.00 IN →

1.00
IN

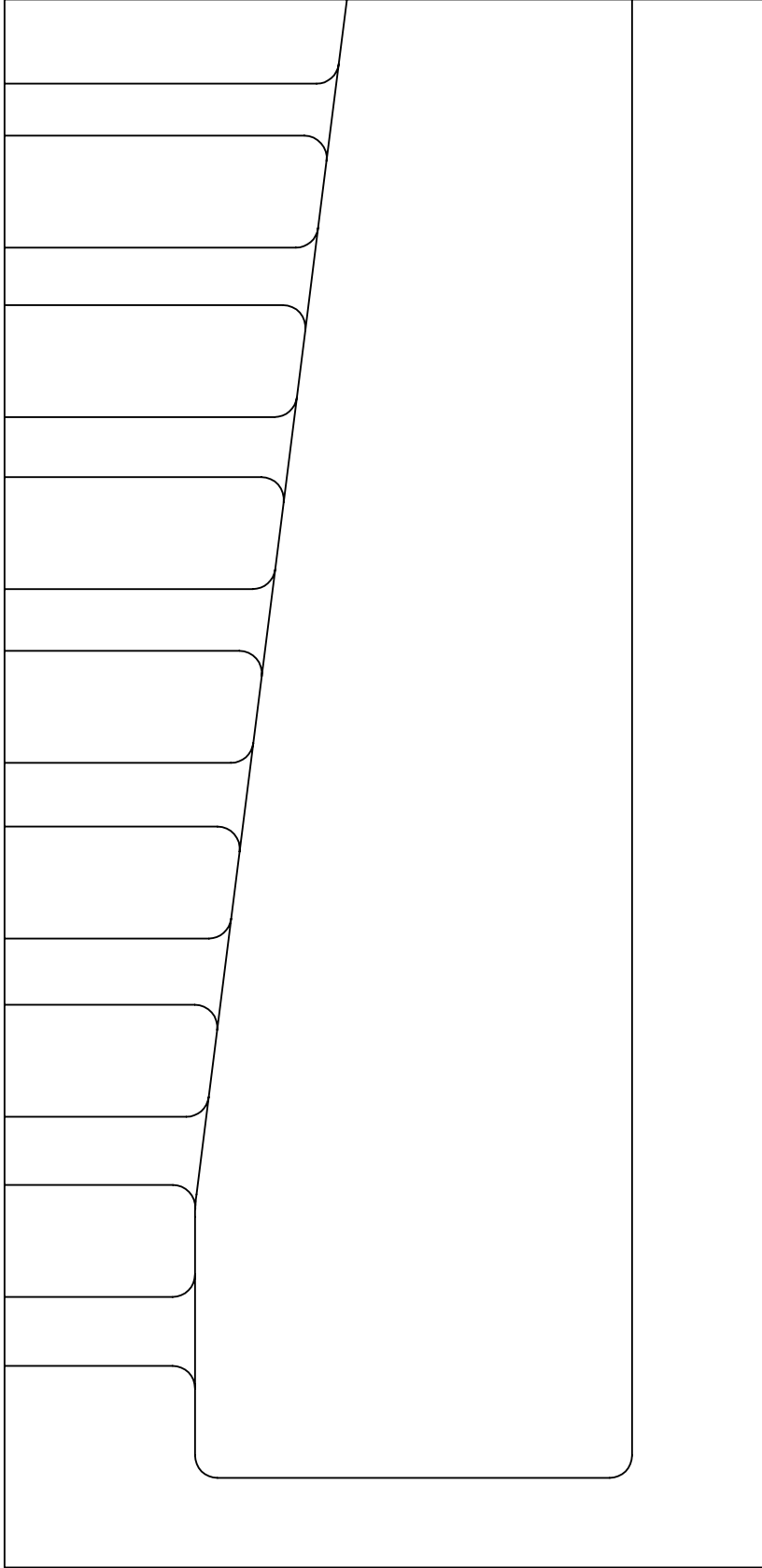

PAGE KEY



DATE CREATED

03 SEP 2015

PART NUMBER

F1A-01153

1.00 IN

PAGE KEY

X									
---	--	--	--	--	--	--	--	--	--

1.00 IN

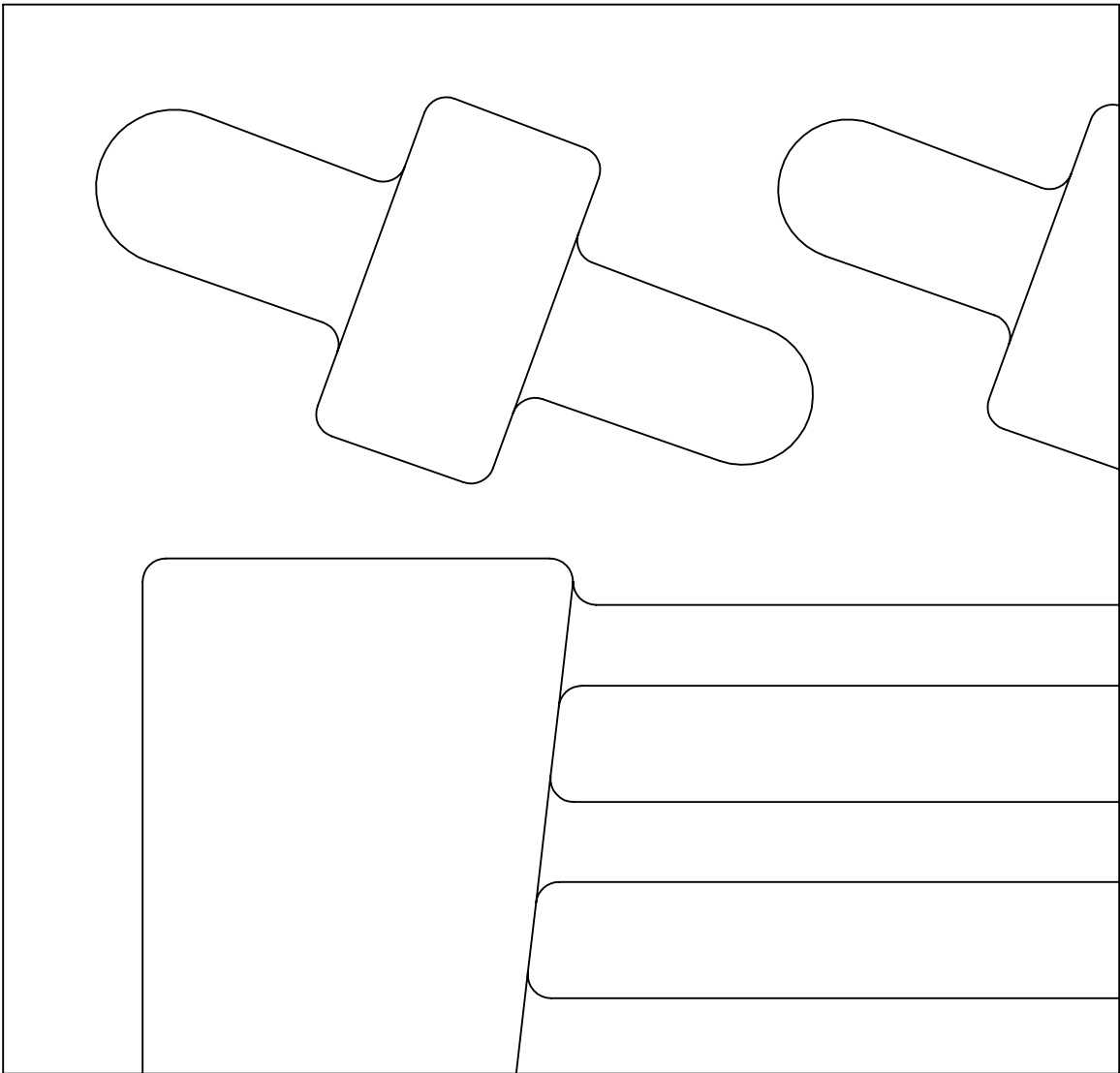

Print on Letter at 100%

DATE CREATED

03 SEP 2015

PART NUMBER

F1A-01153

1.00 IN

PAGE KEY

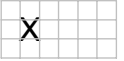

1.00
IN

Print on Letter at 100%

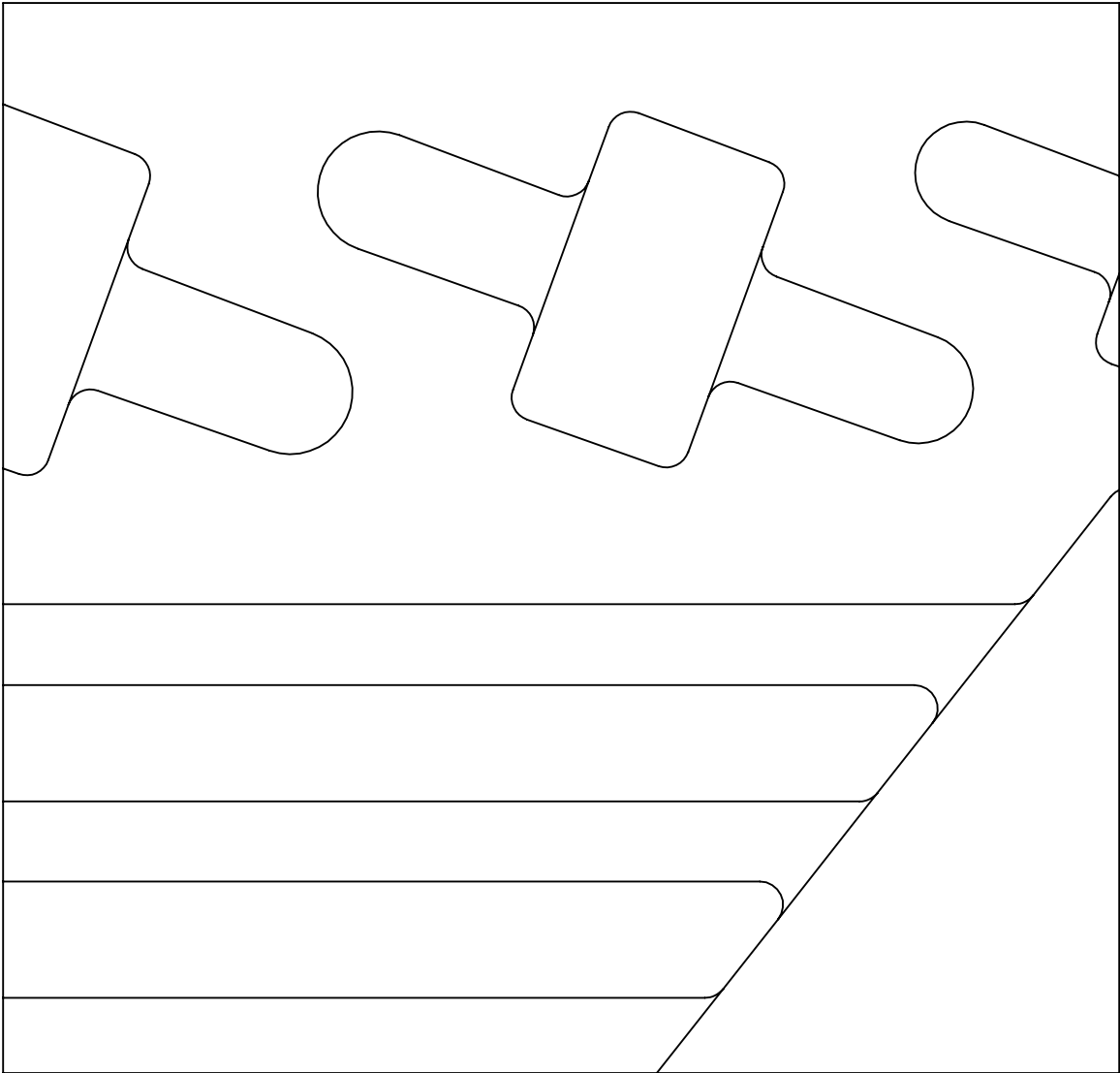

DATE CREATED

03 SEP 2015

PART NUMBER

F1A-01153

1.00 IN

PAGE KEY

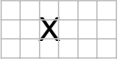

1.00
IN

Print on Letter at 100%

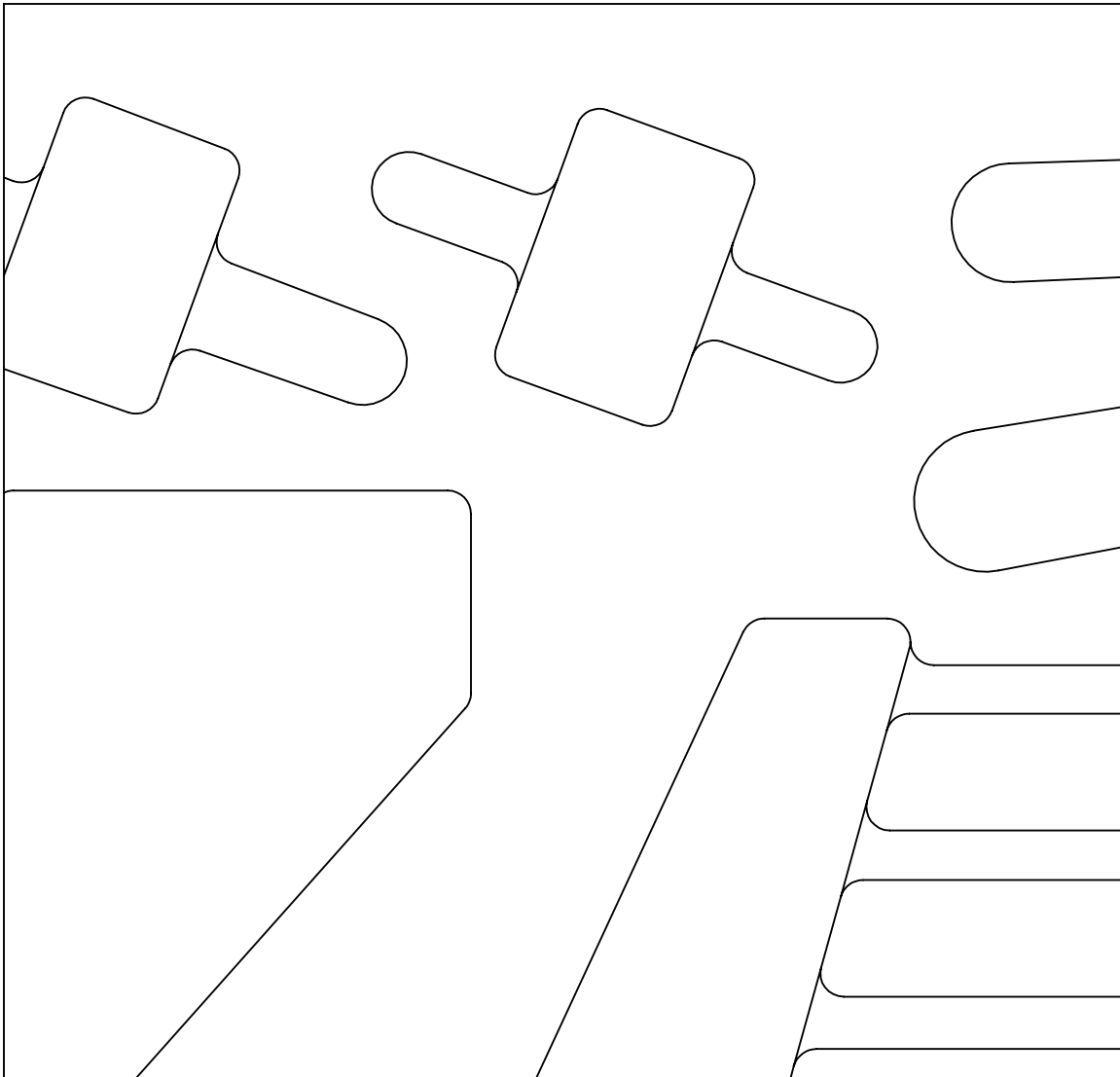

DATE CREATED

03 SEP 2015

PART NUMBER

F1A-01153

1.00 IN

PAGE KEY



1.00
IN

Print on Letter at 100%

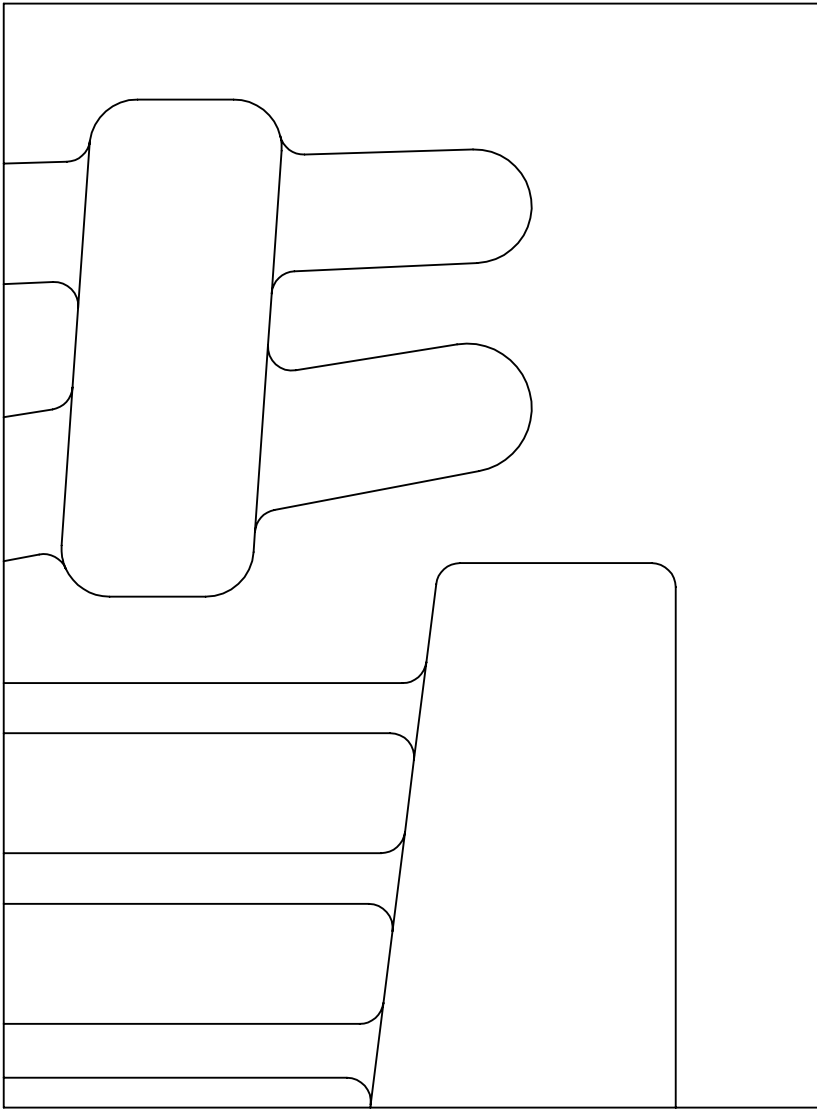

DATE CREATED

03 SEP 2015

PART NUMBER

F1A-01153