

PRINTING INSTRUCTIONS

We recommend printing at full-scale to check the fit with your tools before ordering.

Option 1: Print this page full-scale on a large-format printer (E-Size, 44 inches X 34 inches).

Option 2: Print page 2 - 10 on 8-1/2 X 11 inch paper and assemble.

Thank You!

THE INFORMATION CONTAINED ON THIS DRAWING IS THE SOLE PROPERTY OF FOAMFIT TOOLS AND MAY NOT BE USED WITHOUT PERMISSION. Copyright 2023 FoamFit Tools

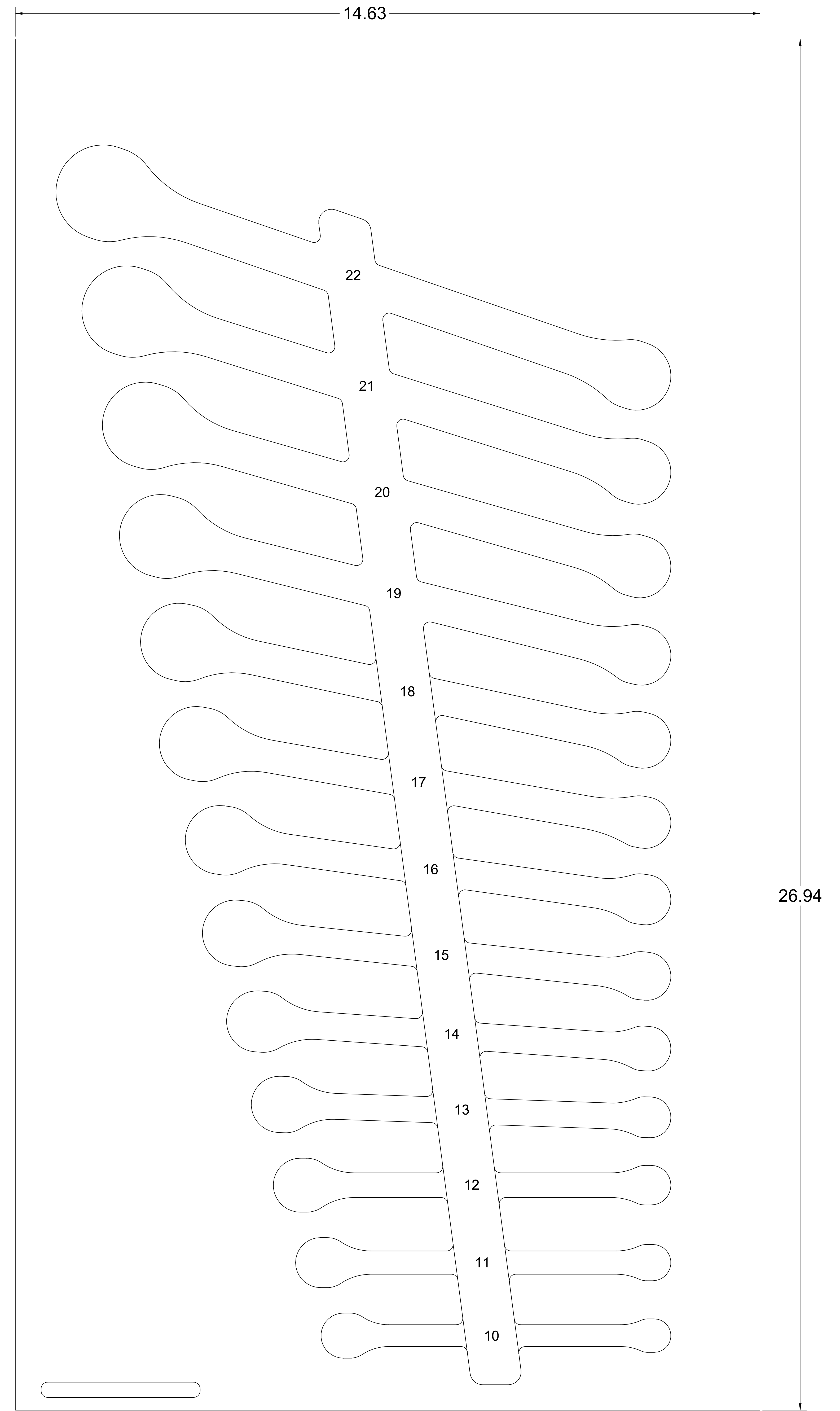
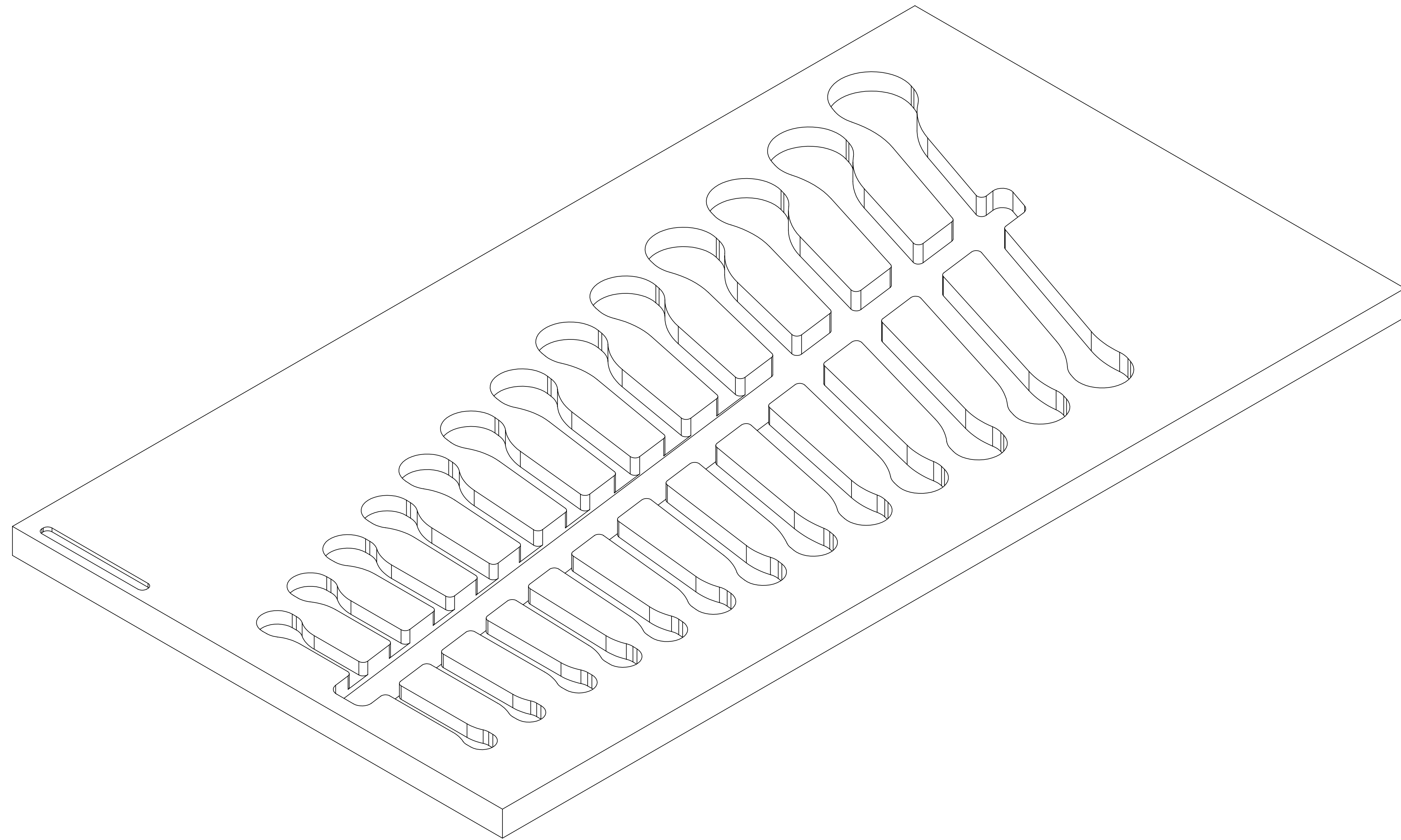

PART NUMBER
F-05459-R

Print on Letter at 100%

1.00
IN

1.00 IN

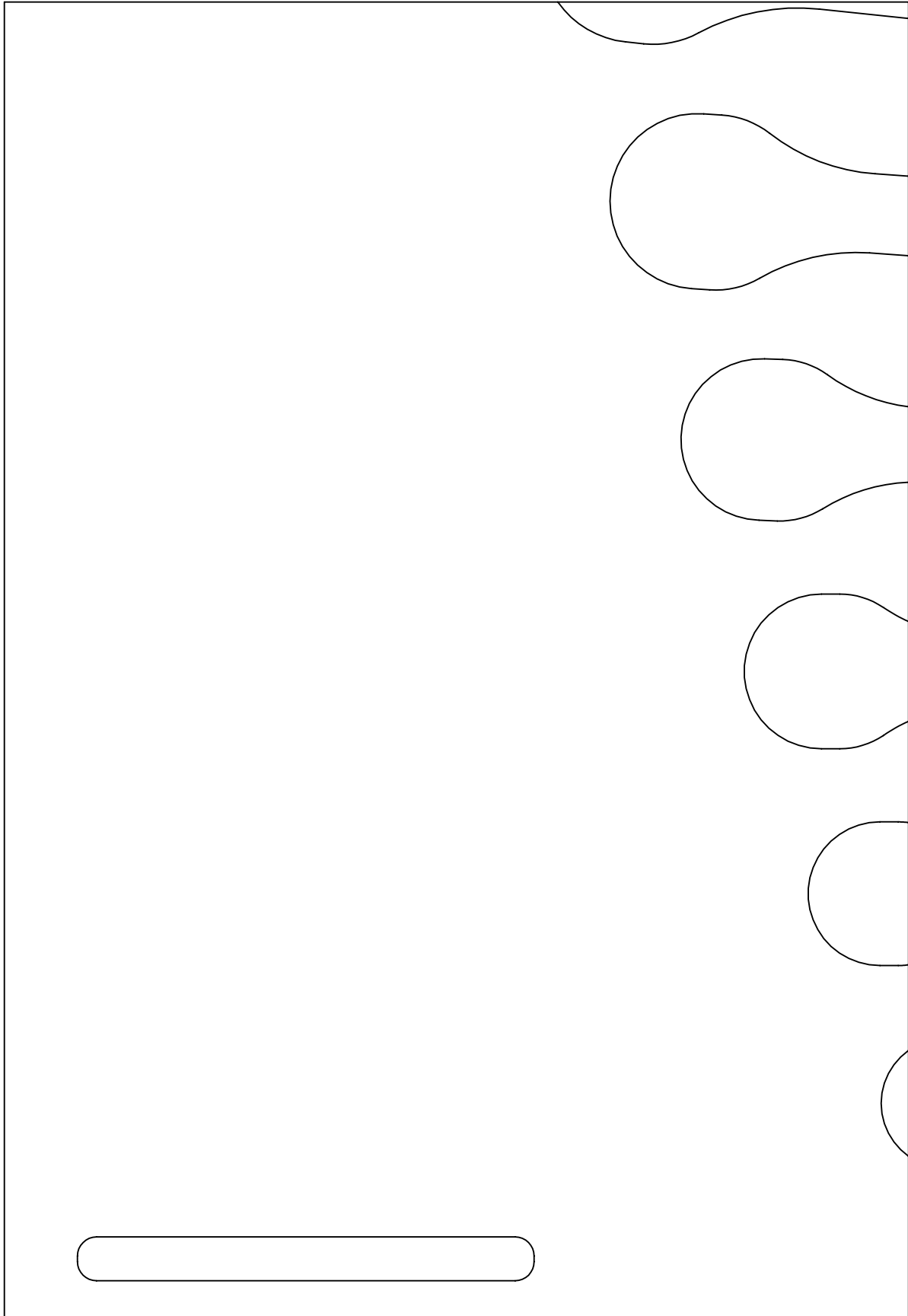

PAGE KEY

X									
---	--	--	--	--	--	--	--	--	--

DATE CREATED

11 DEC 2023

PART NUMBER

F-05459-R

X				

← 1.00 IN →

↑ 1.00 IN ↓

Print on Letter at 100%

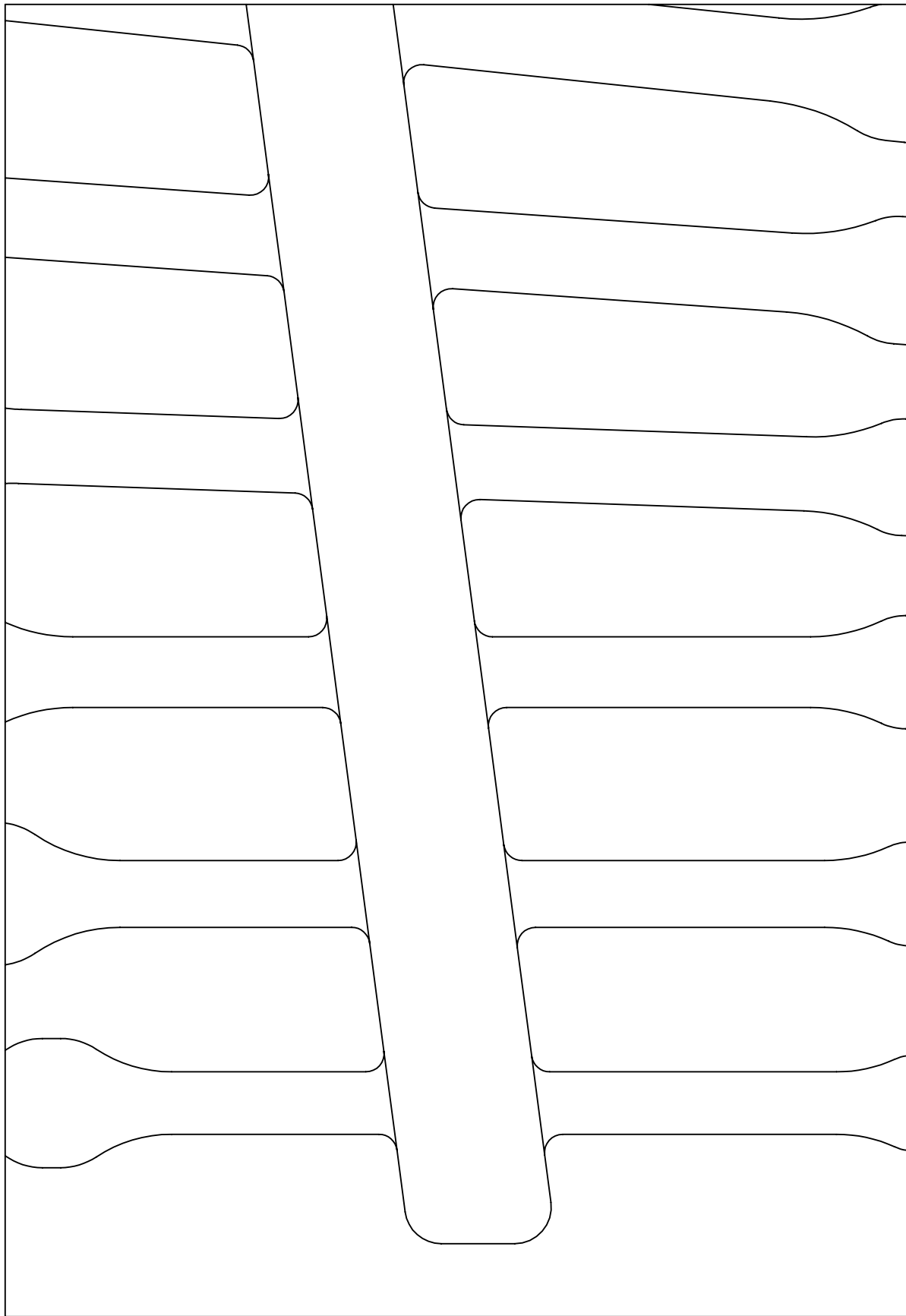

DATE CREATED

11 DEC 2023

PART NUMBER

F-05459-R



Print on Letter at 100%

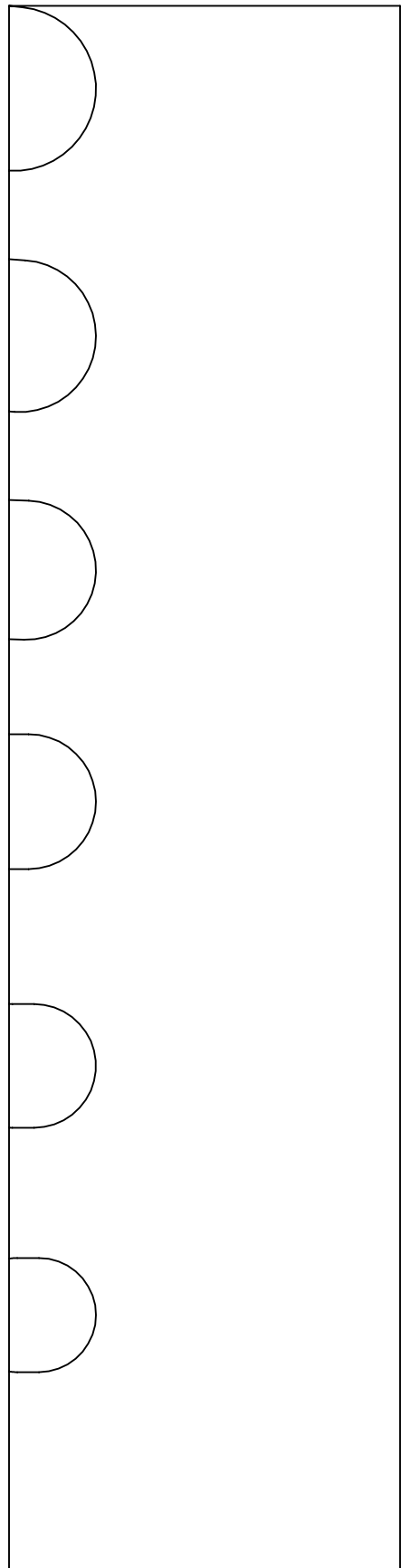

DATE CREATED

11 DEC 2023

PART NUMBER

F-05459-R

← 1.00 IN →

↑ 1.00 IN ↓

PAGE KEY

X									
---	--	--	--	--	--	--	--	--	--

Print on Letter at 100%

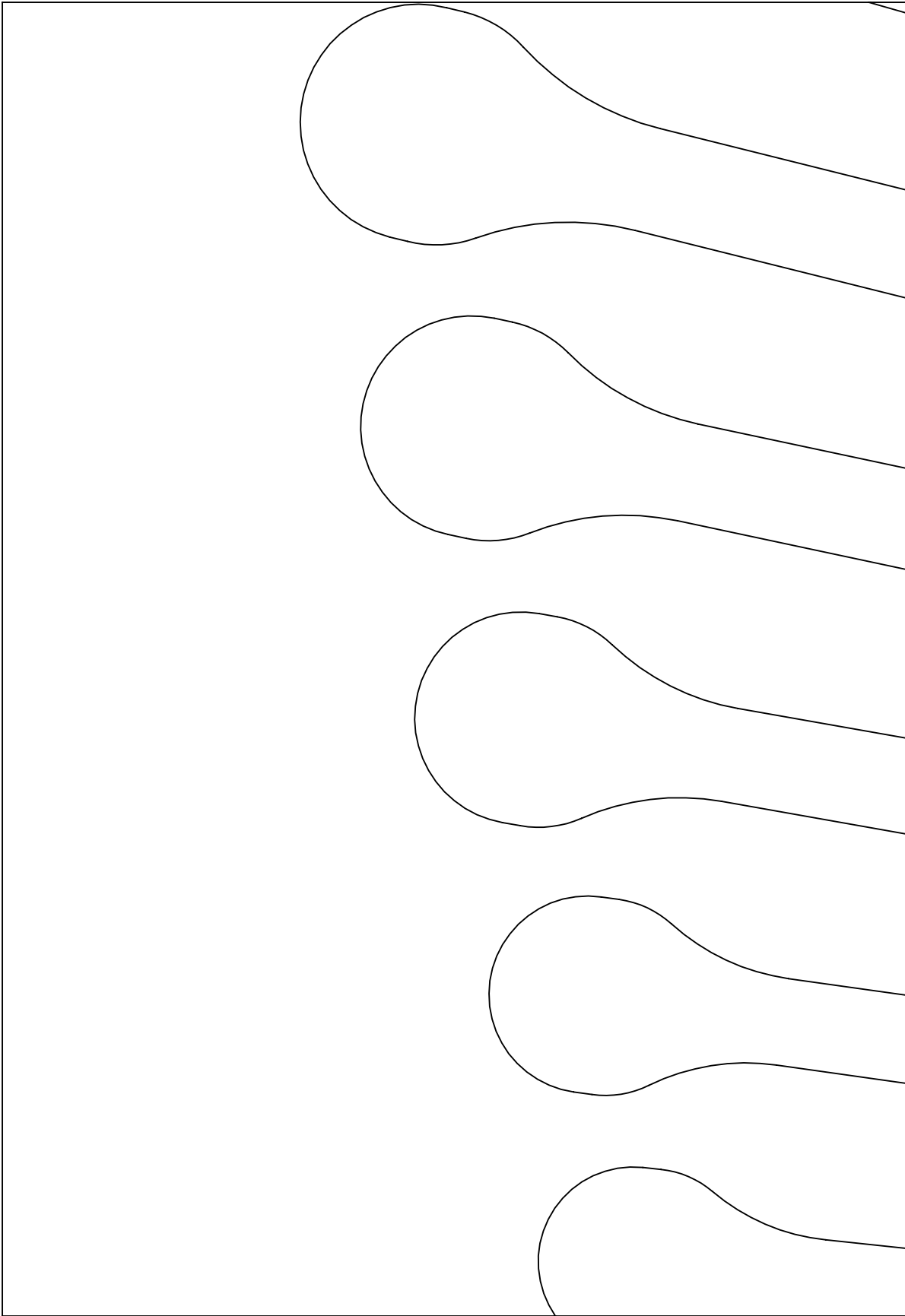

DATE CREATED

11 DEC 2023

PART NUMBER

F-05459-R

← 1.00 IN →

PAGE KEY

X									
---	--	--	--	--	--	--	--	--	--

1.00
IN

Print on Letter at 100%

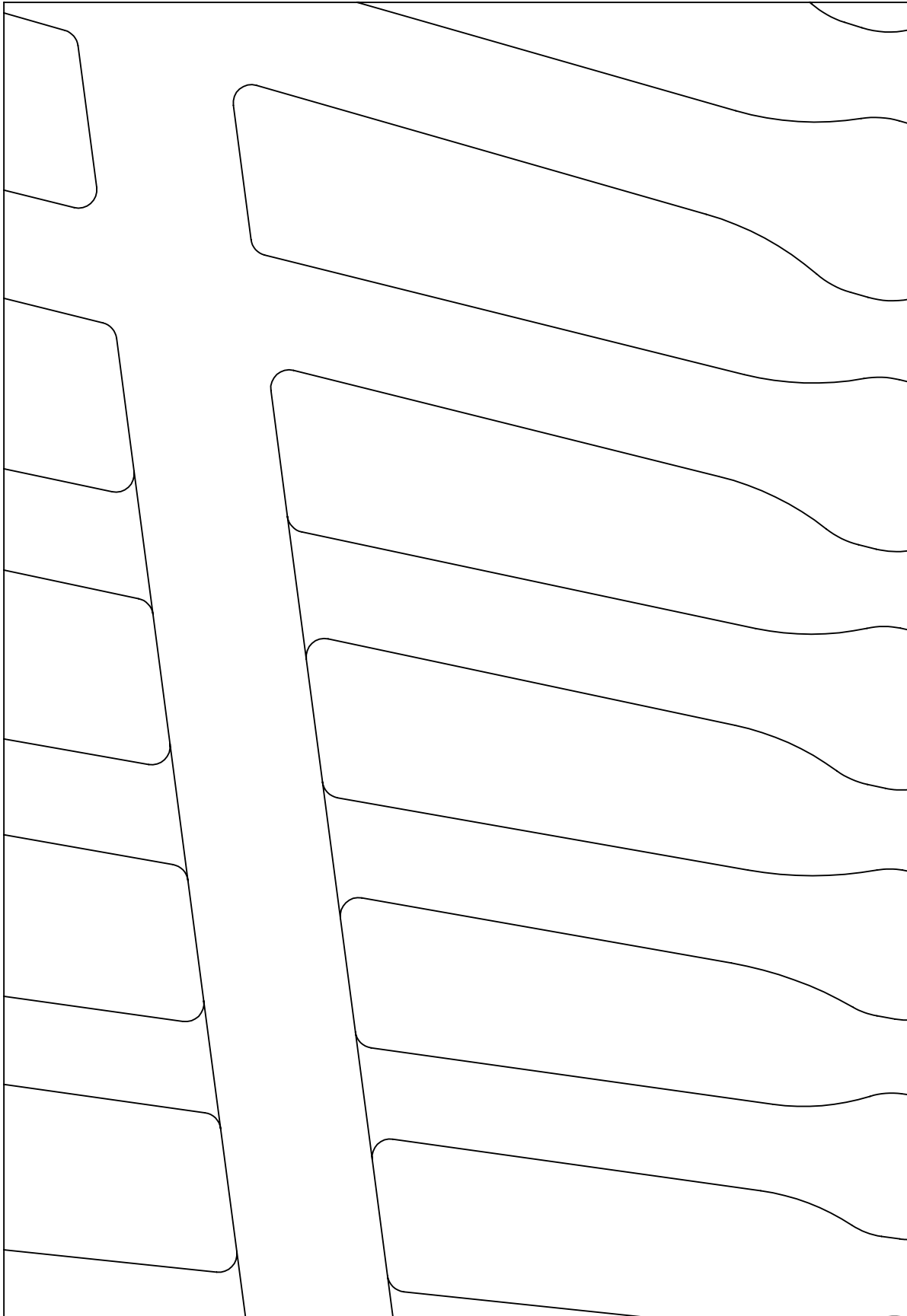

DATE CREATED
11 DEC 2023

PART NUMBER
F-05459-R

X

Print on Letter at 100%

1.00
IN

1.00 IN

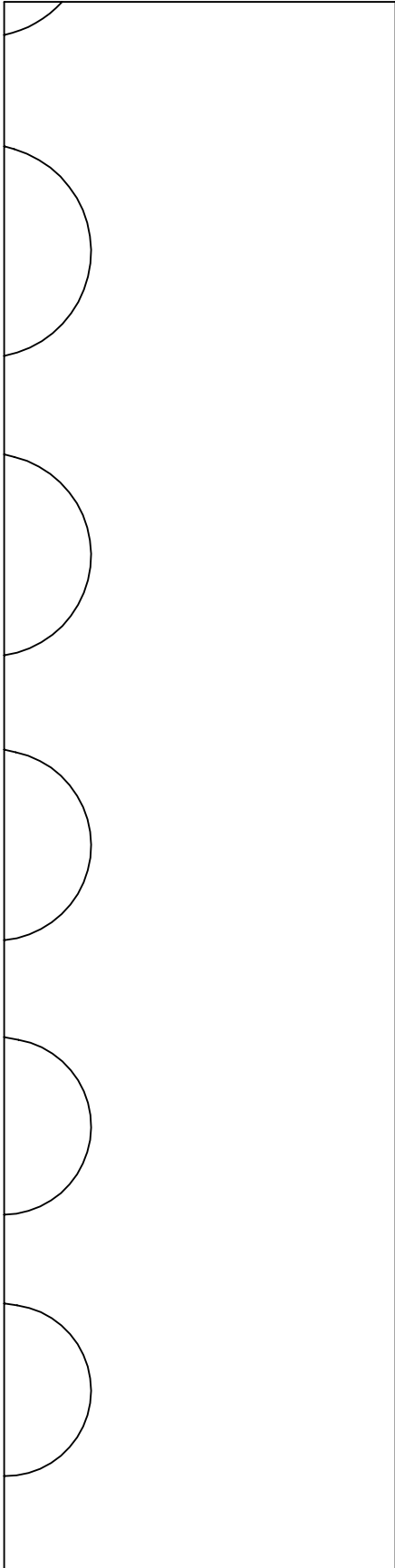

DATE CREATED

11 DEC 2023

PART NUMBER

F-05459-R

1.00 IN

PAGE KEY

X									

1.00
IN

Print on Letter at 100%

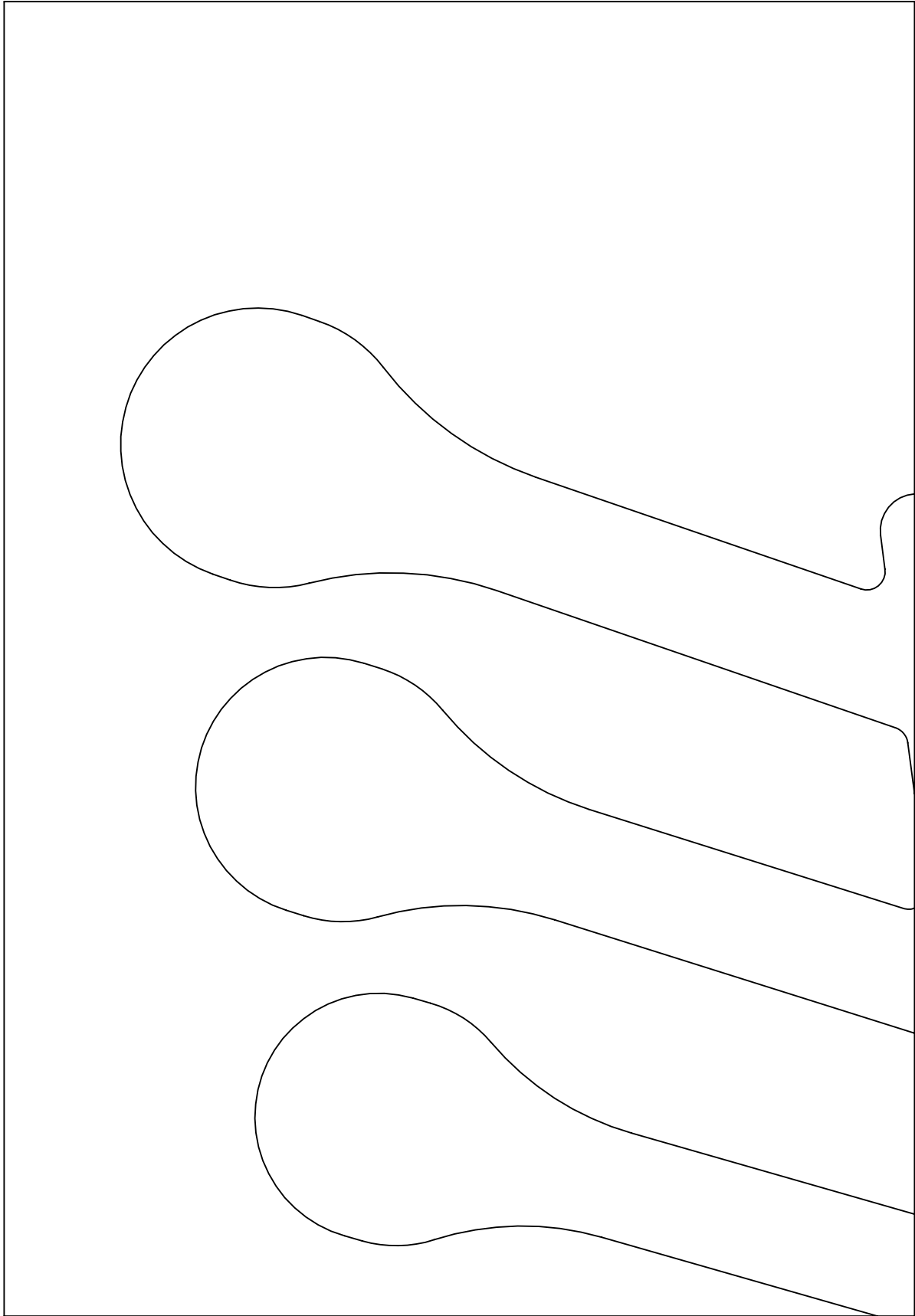

DATE CREATED

11 DEC 2023

PART NUMBER

F-05459-R

1.00 IN

PAGE KEY

X									

1.00
IN

Print on Letter at 100%

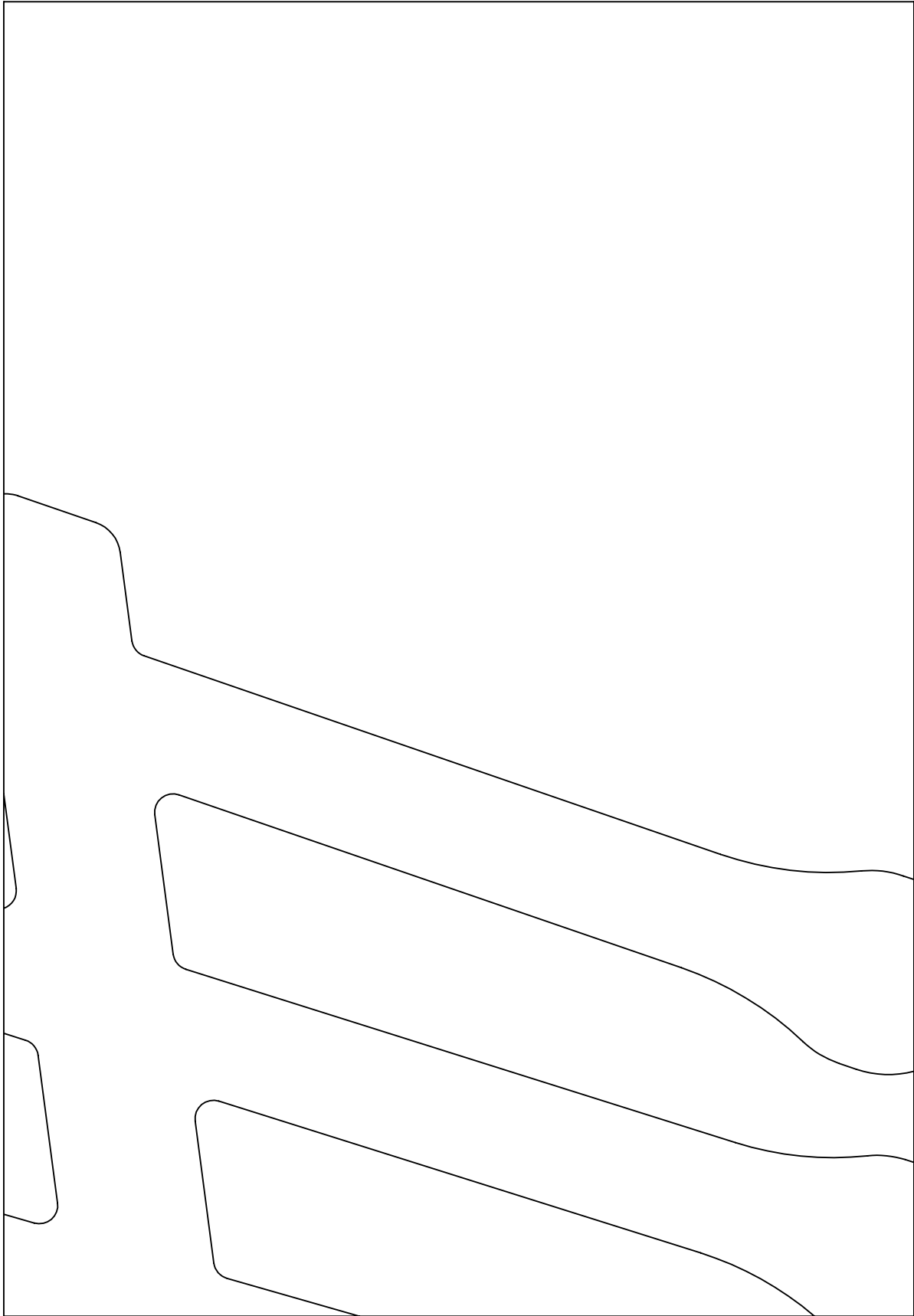

DATE CREATED

11 DEC 2023

PART NUMBER

F-05459-R

	X				

1.00 IN

1.00 IN

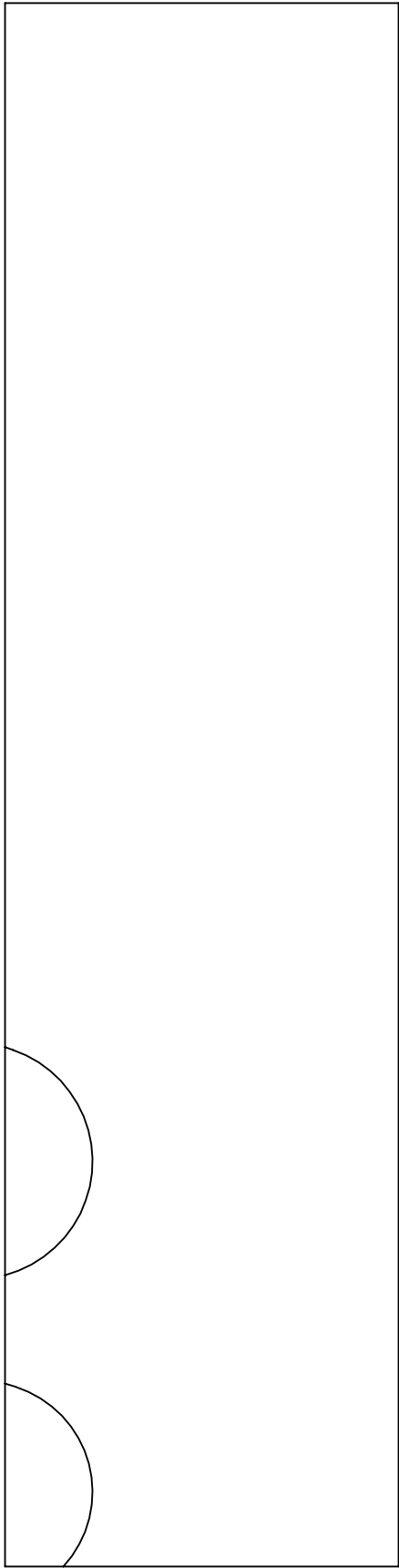

Print on Letter at 100%

DATE CREATED

11 DEC 2023

PART NUMBER

F-05459-R