

PRINTING INSTRUCTIONS

We recommend printing at full-scale to check the fit with your tools before ordering.

Option 1: Print this page full-scale on a large-format printer (E-Size, 44 inches X 34 inches).

Option 2: Print page 2 - 10 on 8-1/2 X 11 inch paper and assemble.

Thank You!

THE INFORMATION CONTAINED ON THIS DRAWING IS THE SOLE PROPERTY OF FOAMFIT TOOLS AND MAY NOT BE USED WITHOUT PERMISSION. Copyright 2022 FoamFit Tools

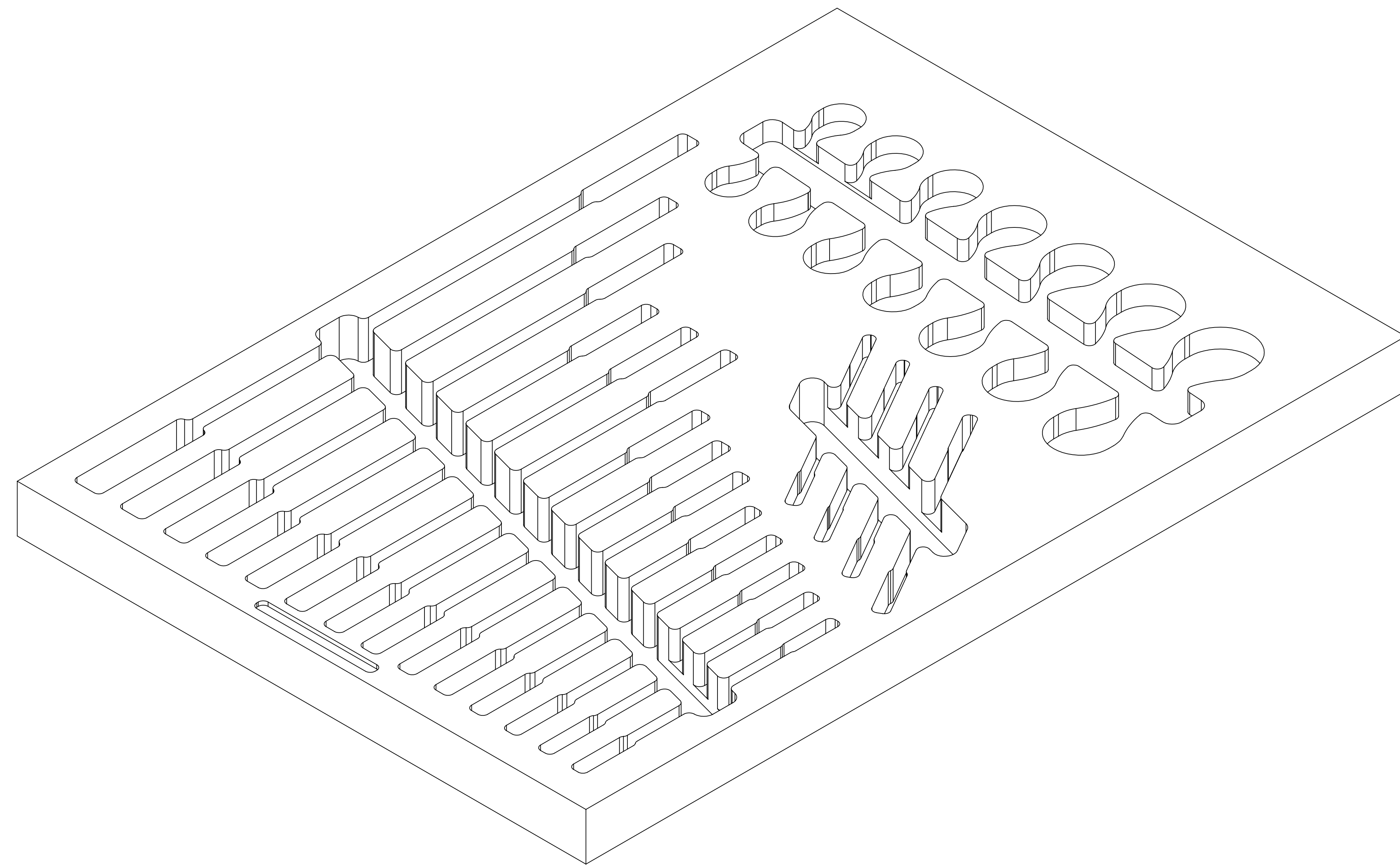

STUBBY
NON-REVERSIBLE
RATCHETING

NON-REVERSIBLE
RATCHETING

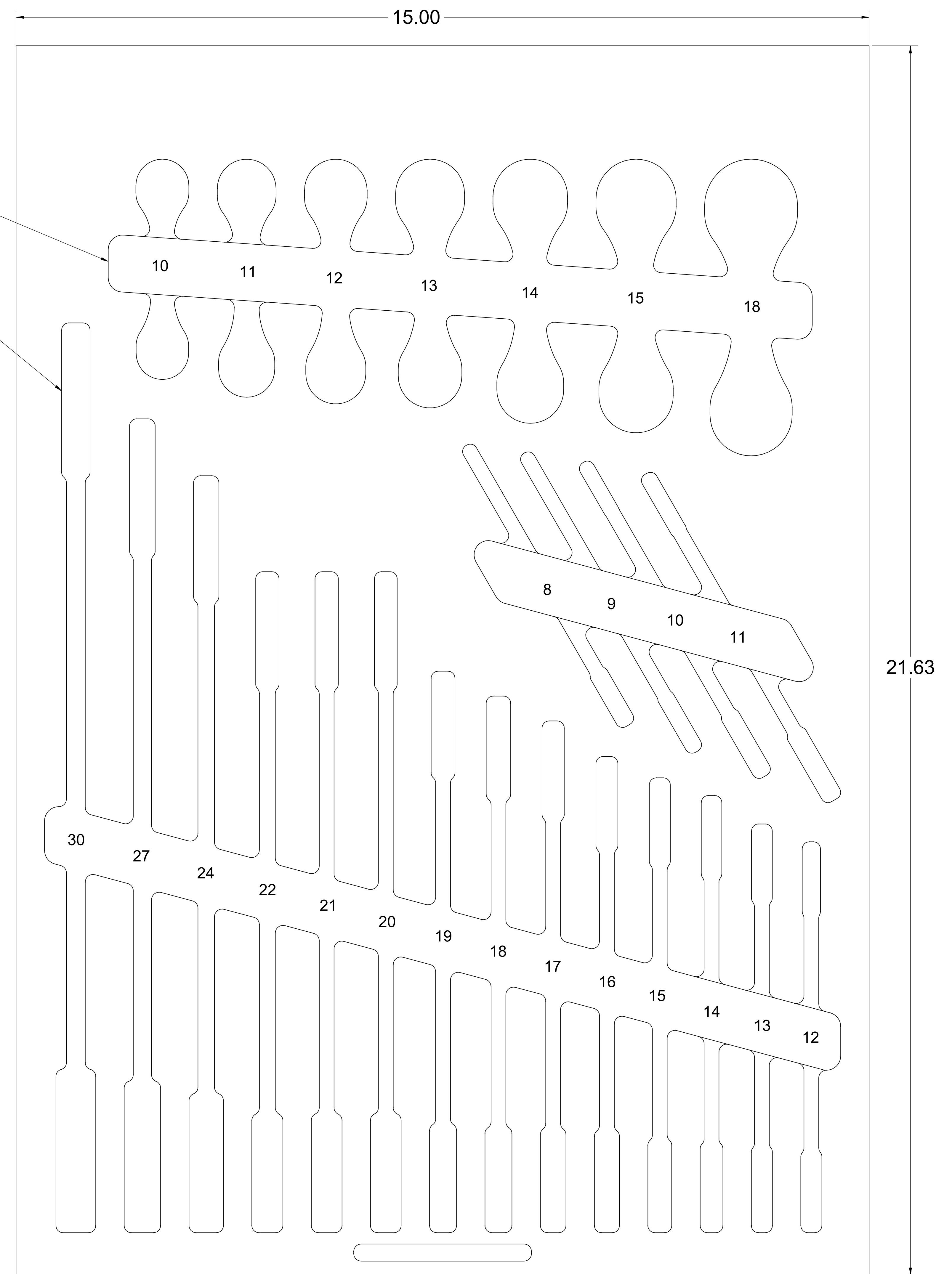

CAUTION
SUGGESTED DRAWER HEIGHT
3.0 MIN

APPROXIMATE TOP OF TALLEST TOOL

PART NUMBER
F-04994-T

Print on Letter at 100%

1.00 IN

1.00 IN

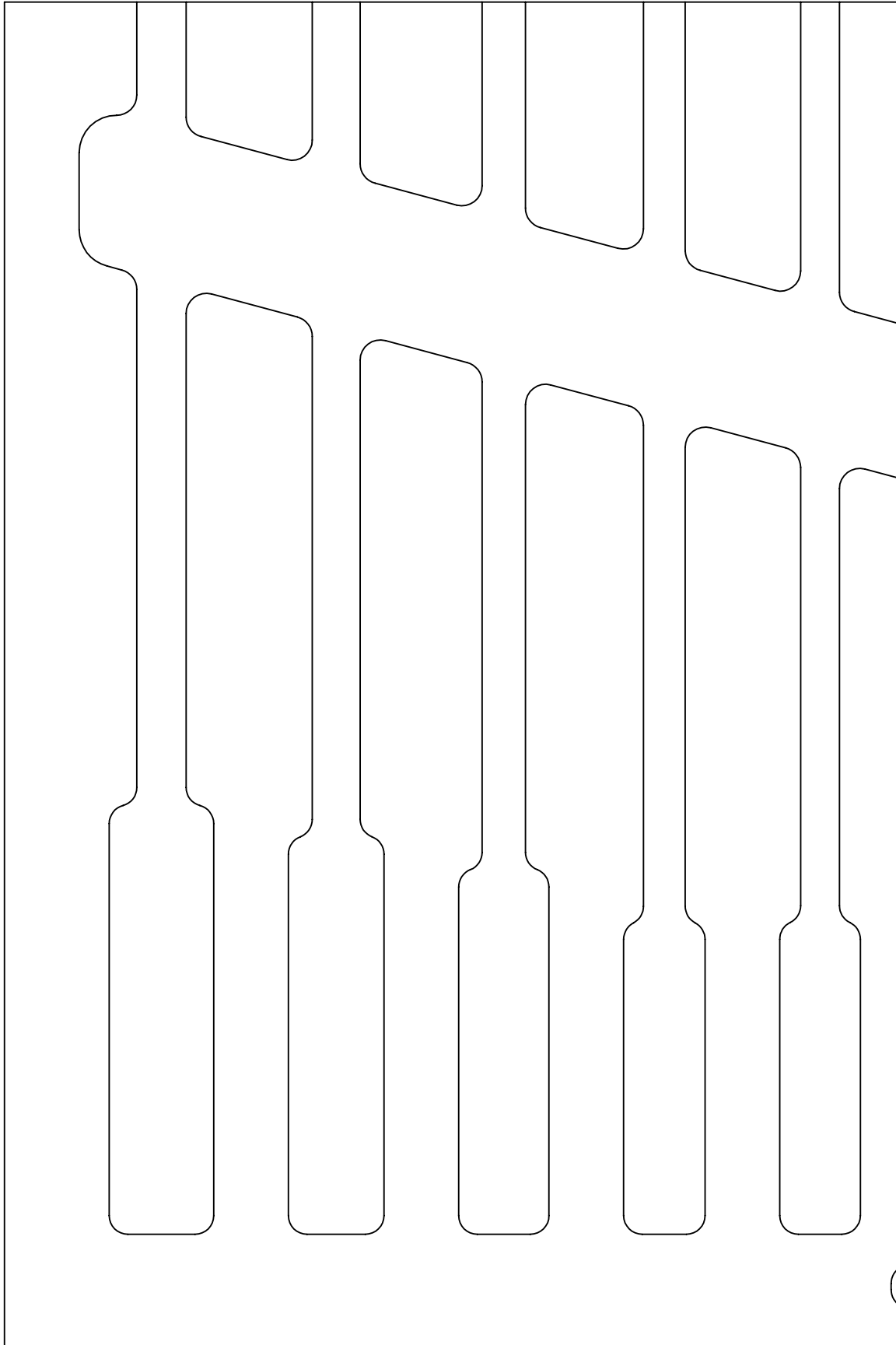

PAGE KEY

X									

DATE CREATED

22 DEC 2022

PART NUMBER

F-04994-T

Print on Letter at 100%

1.00
IN

1.00 IN

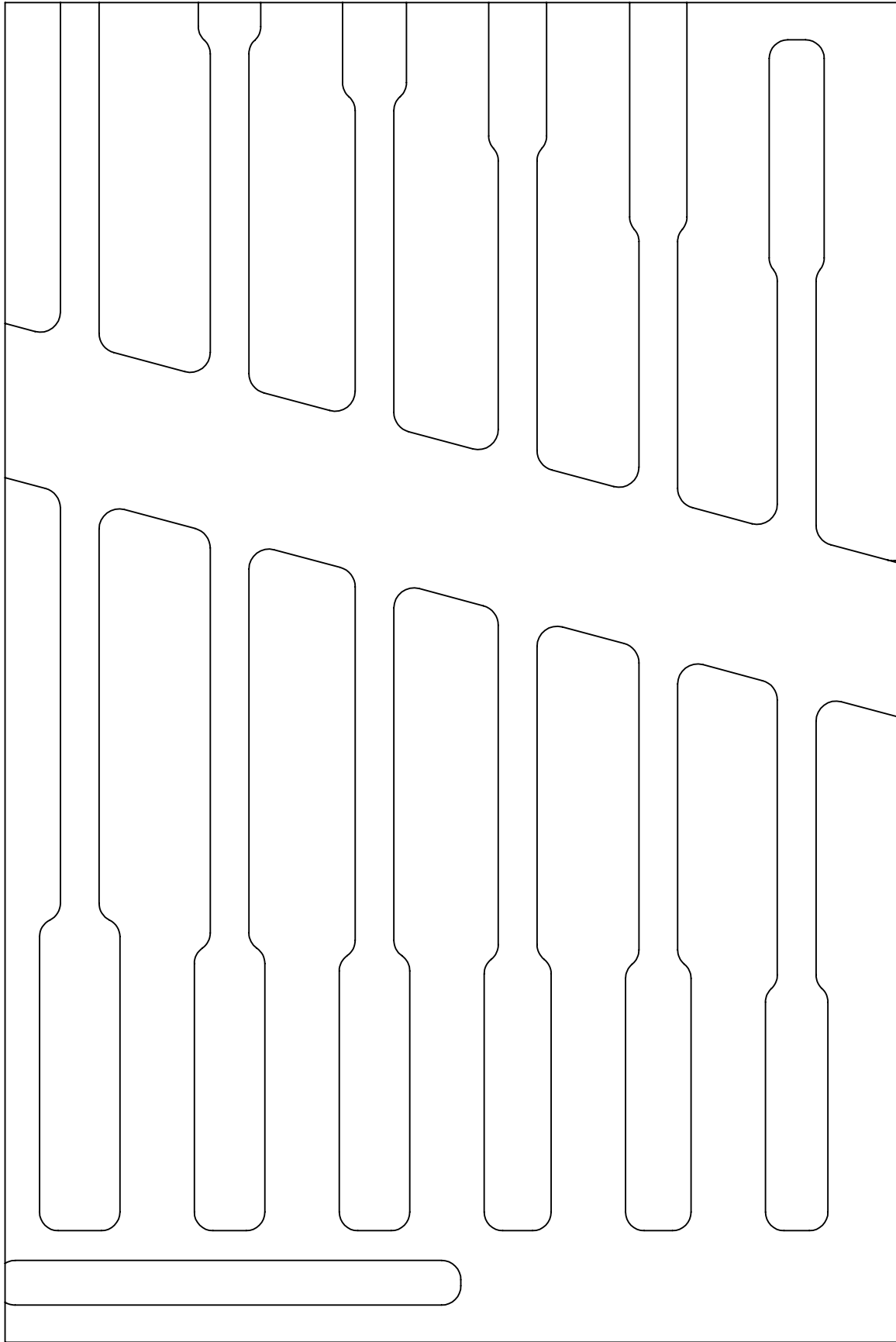

PAGE KEY

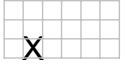

DATE CREATED

22 DEC 2022

PART NUMBER

F-04994-T



Print on Letter at 100%

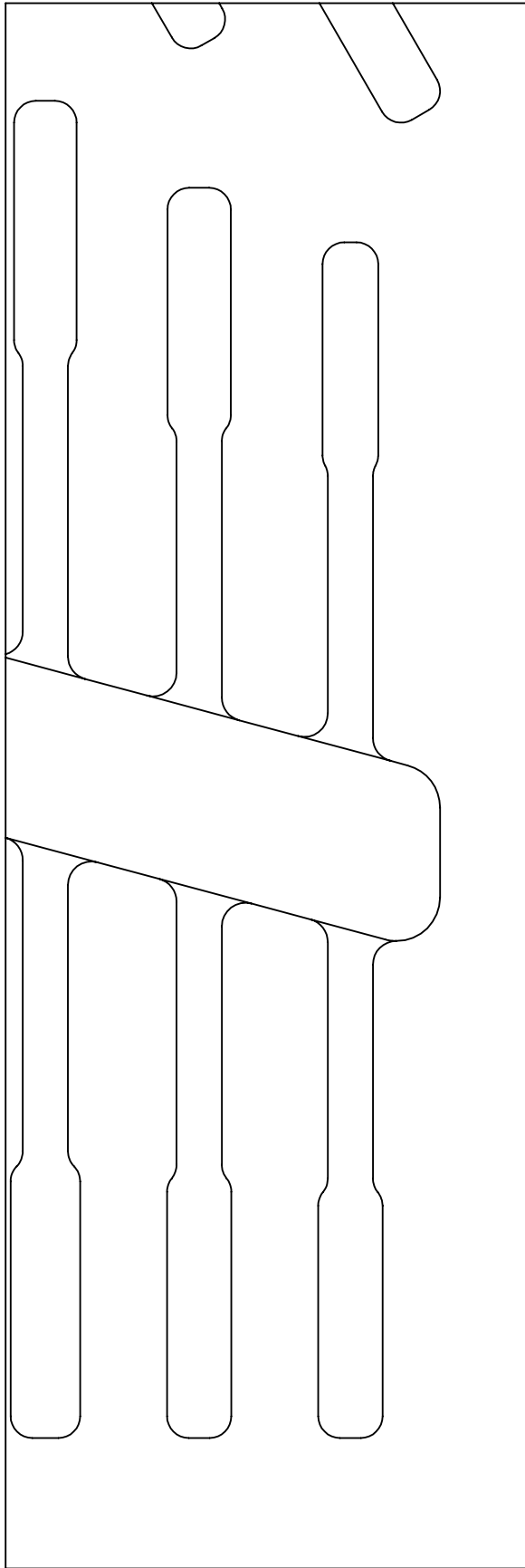

PART NUMBER	DATE CREATED
F-04994-T	22 DEC 2022

1.00 IN

PAGE KEY

X									
---	--	--	--	--	--	--	--	--	--

1.00 IN

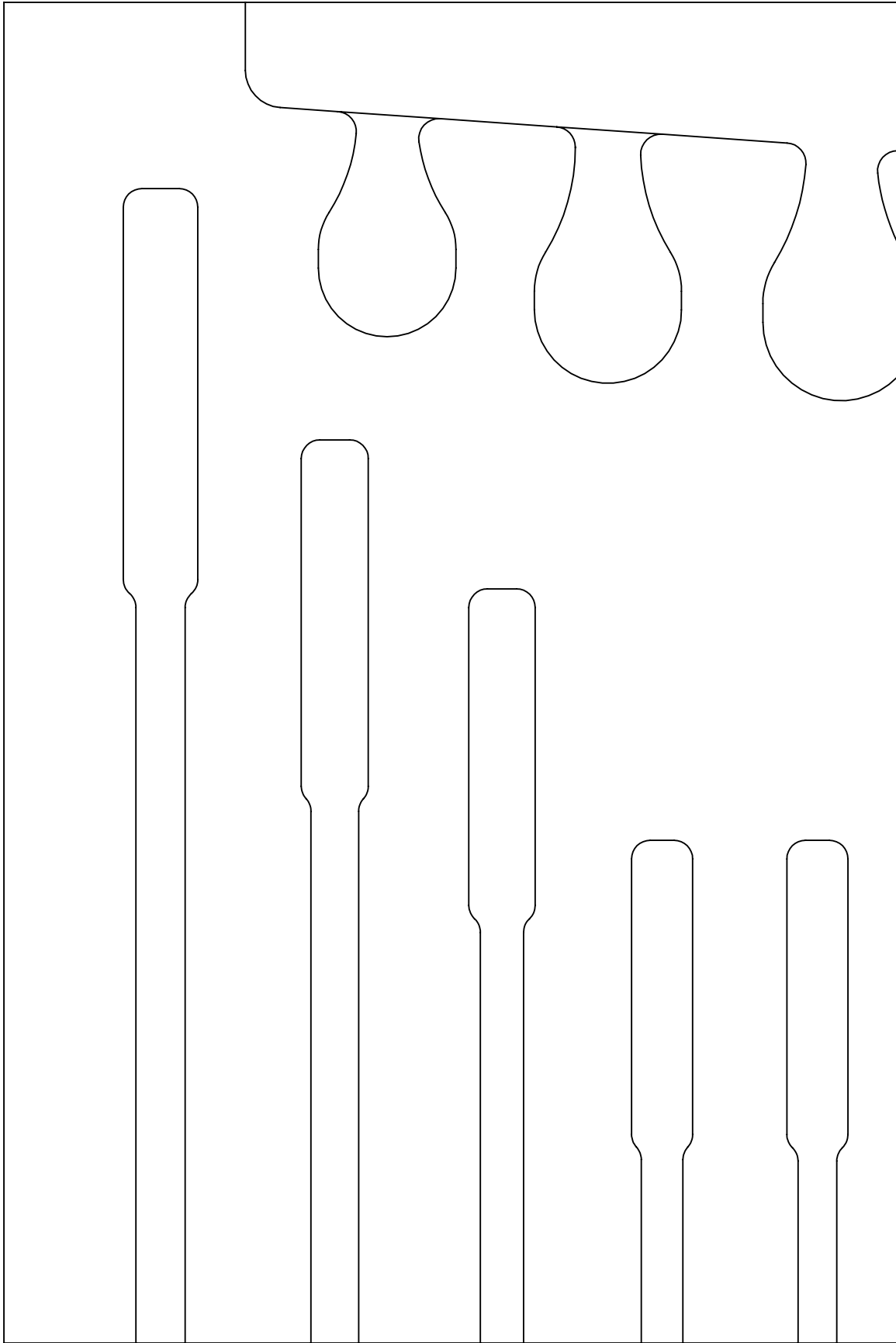

Print on Letter at 100%

DATE CREATED

22 DEC 2022

PART NUMBER

F-04994-T

← 1.00 IN →

PAGE KEY

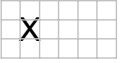

↑ 1.00 IN ↓

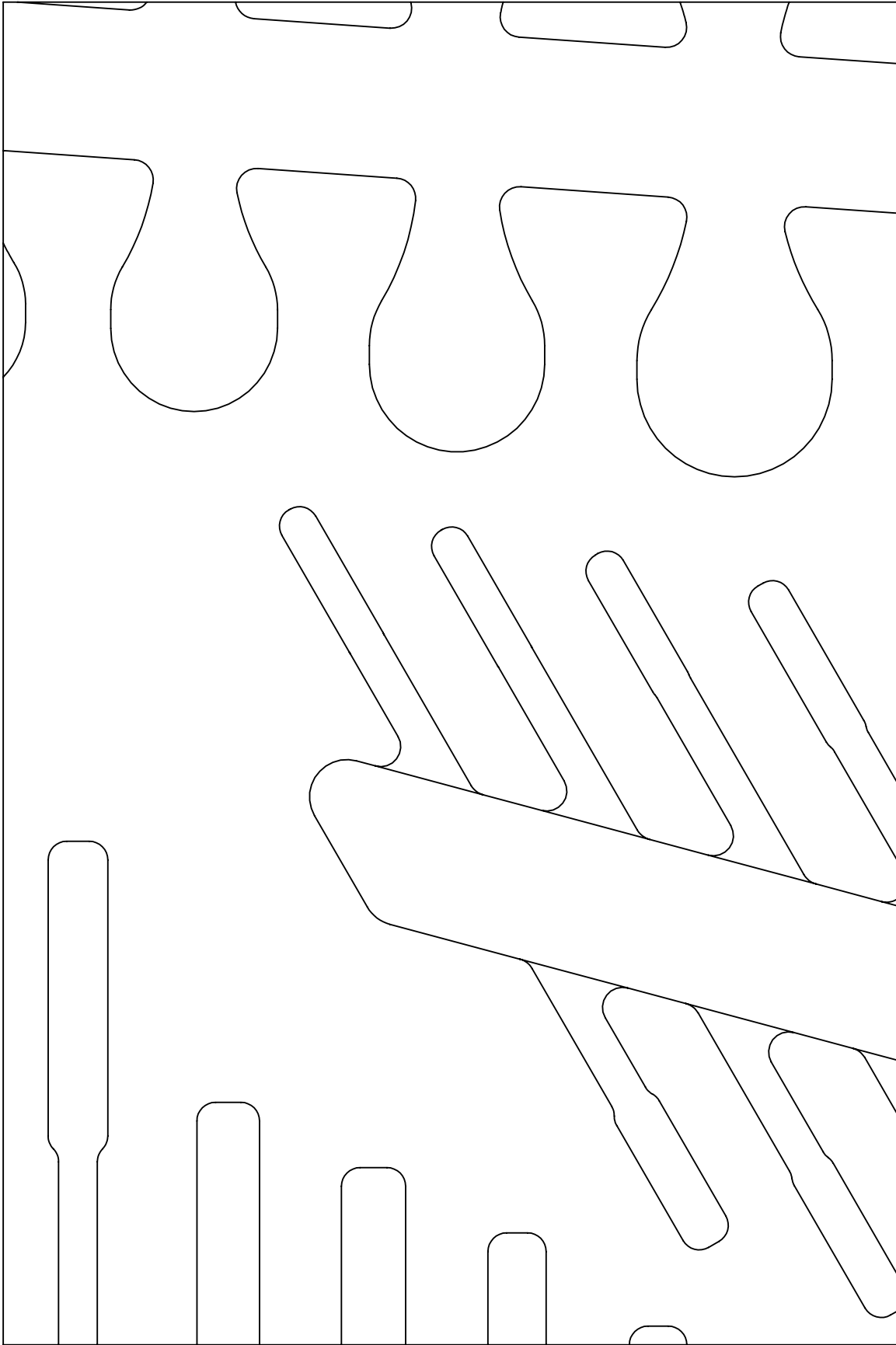

Print on Letter at 100%

DATE CREATED

22 DEC 2022

PART NUMBER

F-04994-T



Print on Letter at 100%

1.00
IN

1.00 IN

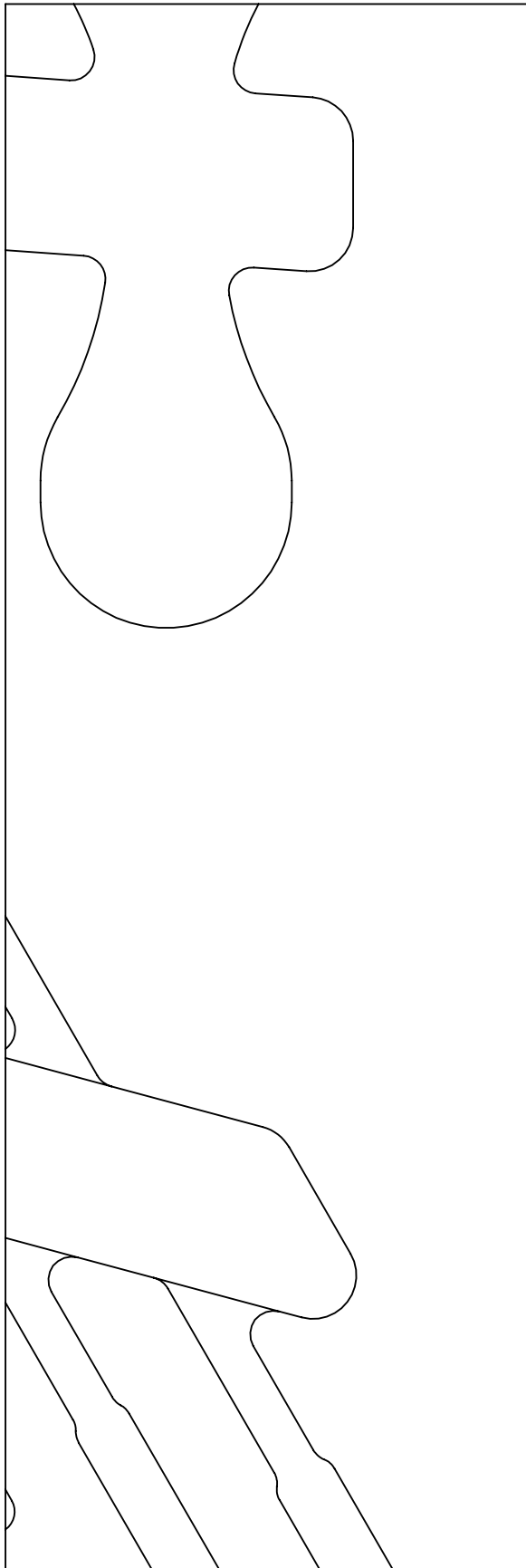

DATE CREATED

22 DEC 2022

PART NUMBER

F-04994-T

1.00 IN

PAGE KEY

X									

1.00 IN

Print on Letter at 100%

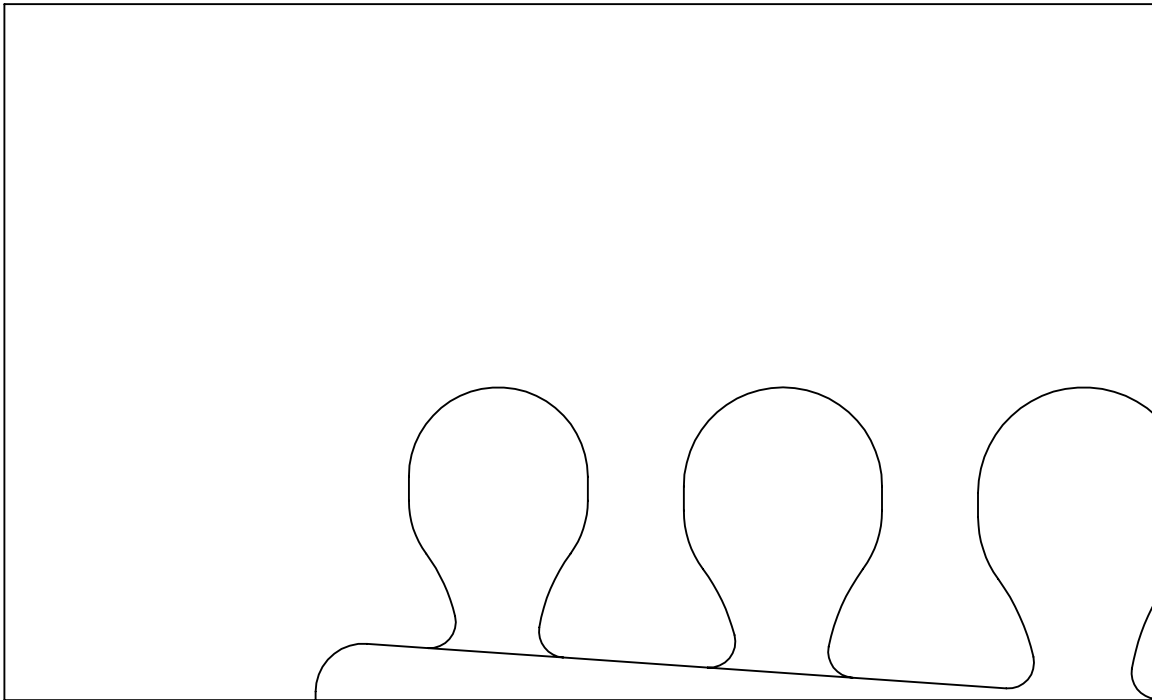

DATE CREATED

22 DEC 2022

PART NUMBER

F-04994-T

1.00 IN

PAGE KEY

X									

1.00 IN

Print on Letter at 100%

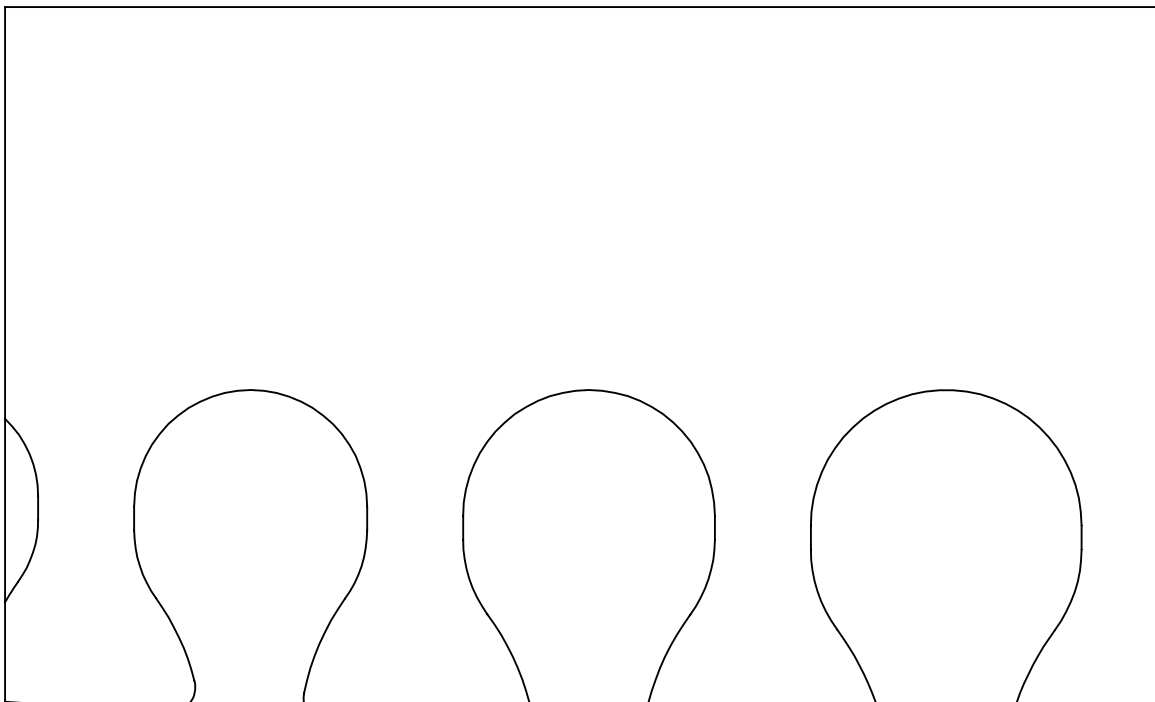

DATE CREATED

22 DEC 2022

PART NUMBER

F-04994-T

1.00 IN

PAGE KEY



1.00
IN

Print on Letter at 100%

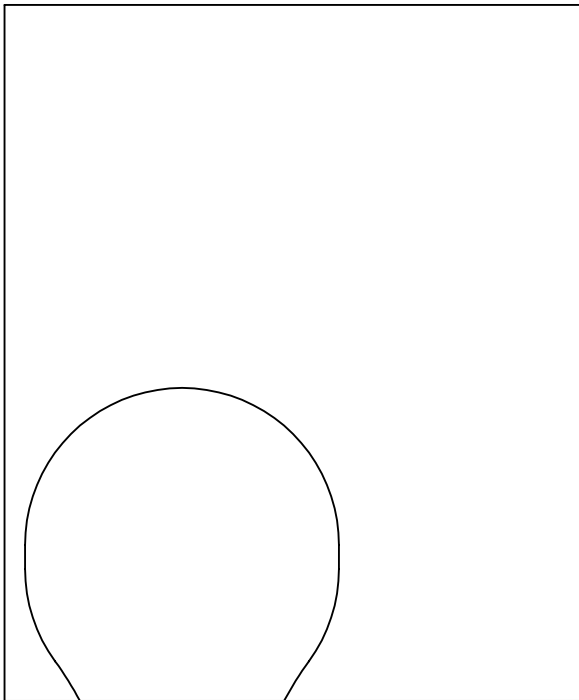

DATE CREATED

22 DEC 2022

PART NUMBER

F-04994-T