

PRINTING INSTRUCTIONS

We recommend printing at full-scale to check the fit with your tools before ordering.

Option 1: Print this page full-scale on a large-format printer (E-Size, 44 inches X 34 inches).

Option 2: Print page 2 - 19 on 8-1/2 X 11 inch paper and assemble.

Thank You!

THE INFORMATION CONTAINED ON THIS DRAWING IS THE SOLE PROPERTY OF FOAMFIT TOOLS AND MAY NOT BE USED WITHOUT PERMISSION. Copyright 2019 FoamFit Tools

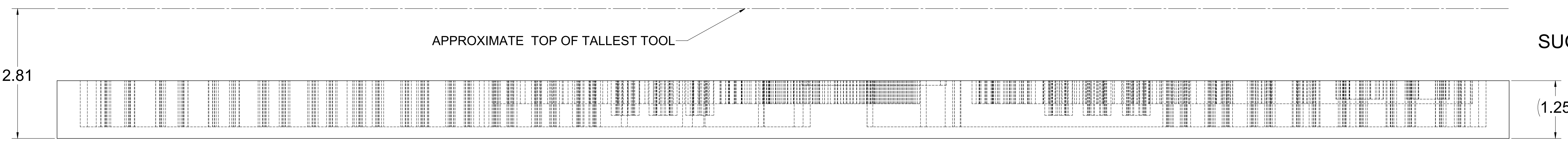
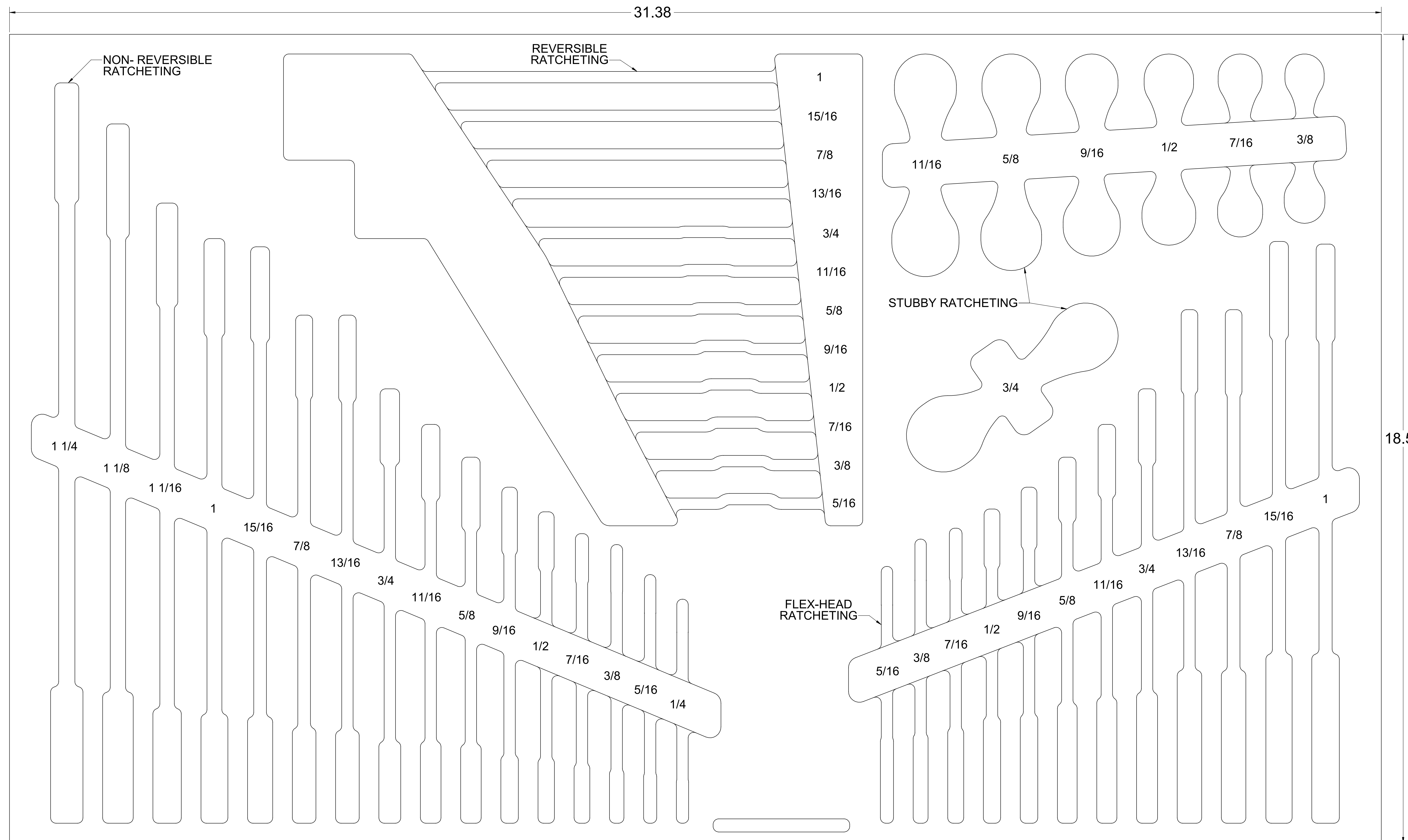
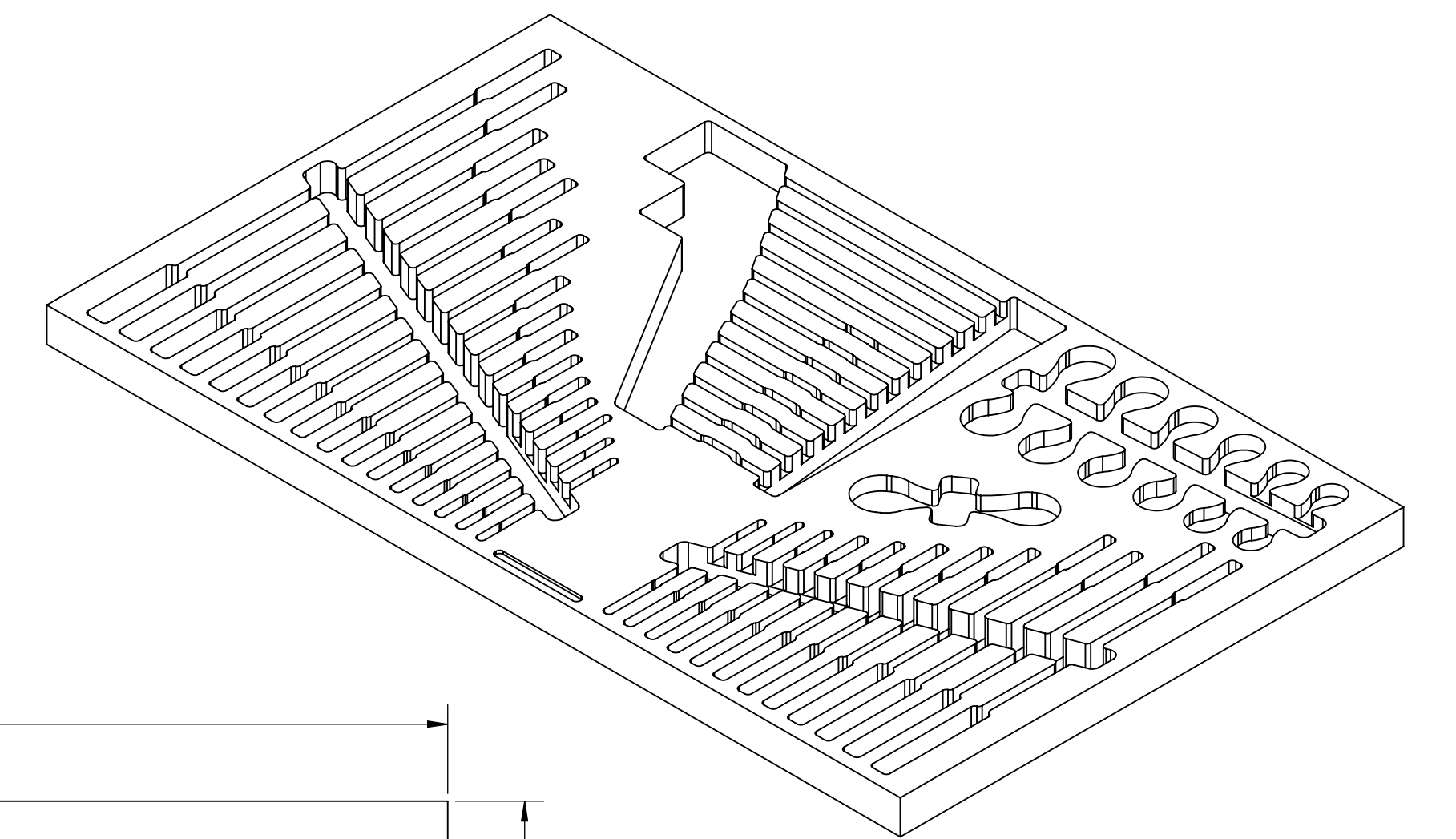

CAUTION
SUGGESTED DRAWER HEIGHT
3" MIN

PART NUMBER
F-03437-T

← 1.00 IN →

PAGE KEY

X									

1.00
IN

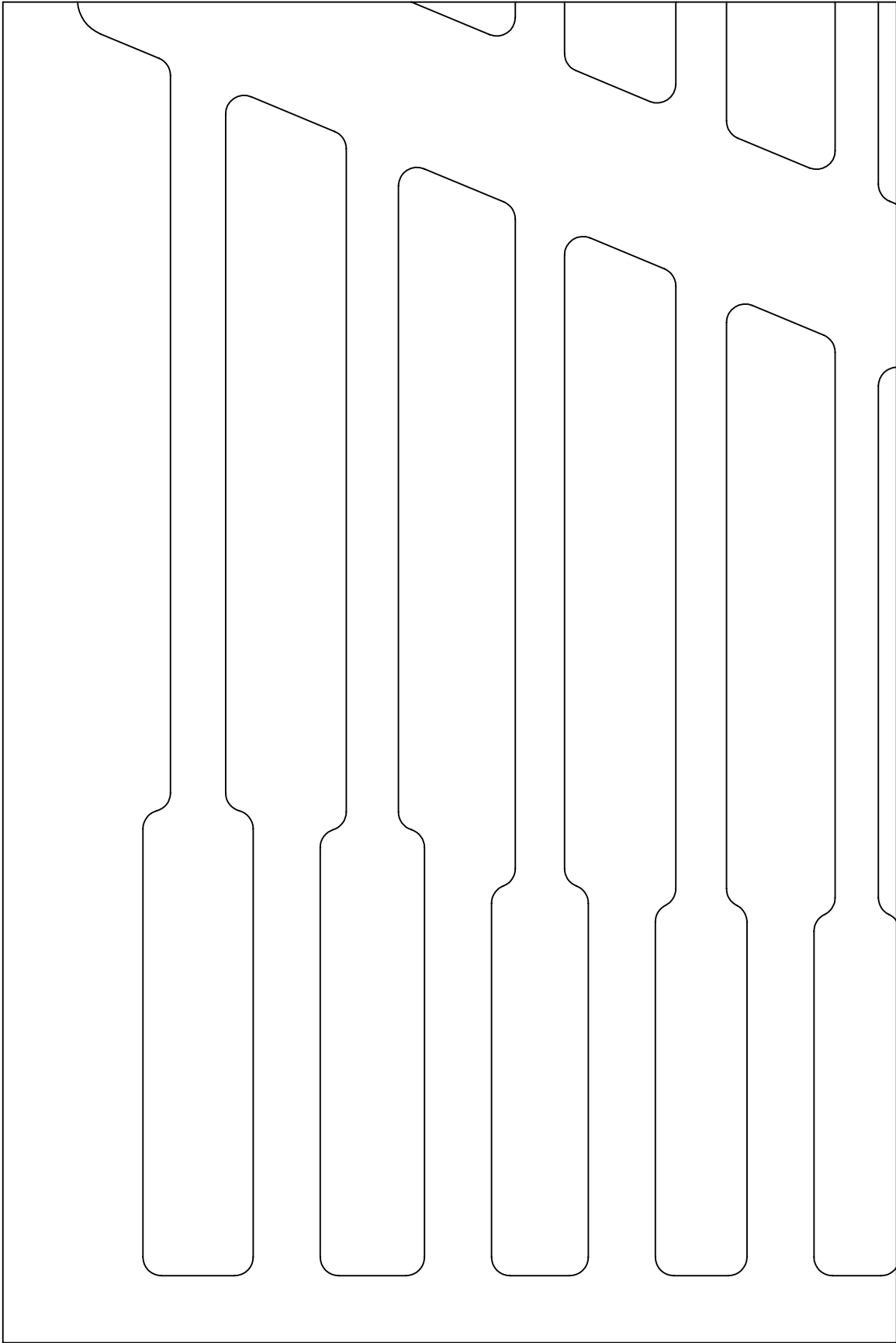

Print on Letter at 100%

DATE CREATED

19 DEC 2019

PART NUMBER

F-03437-T

Print on Letter at 100%

1.00
IN

1.00 IN

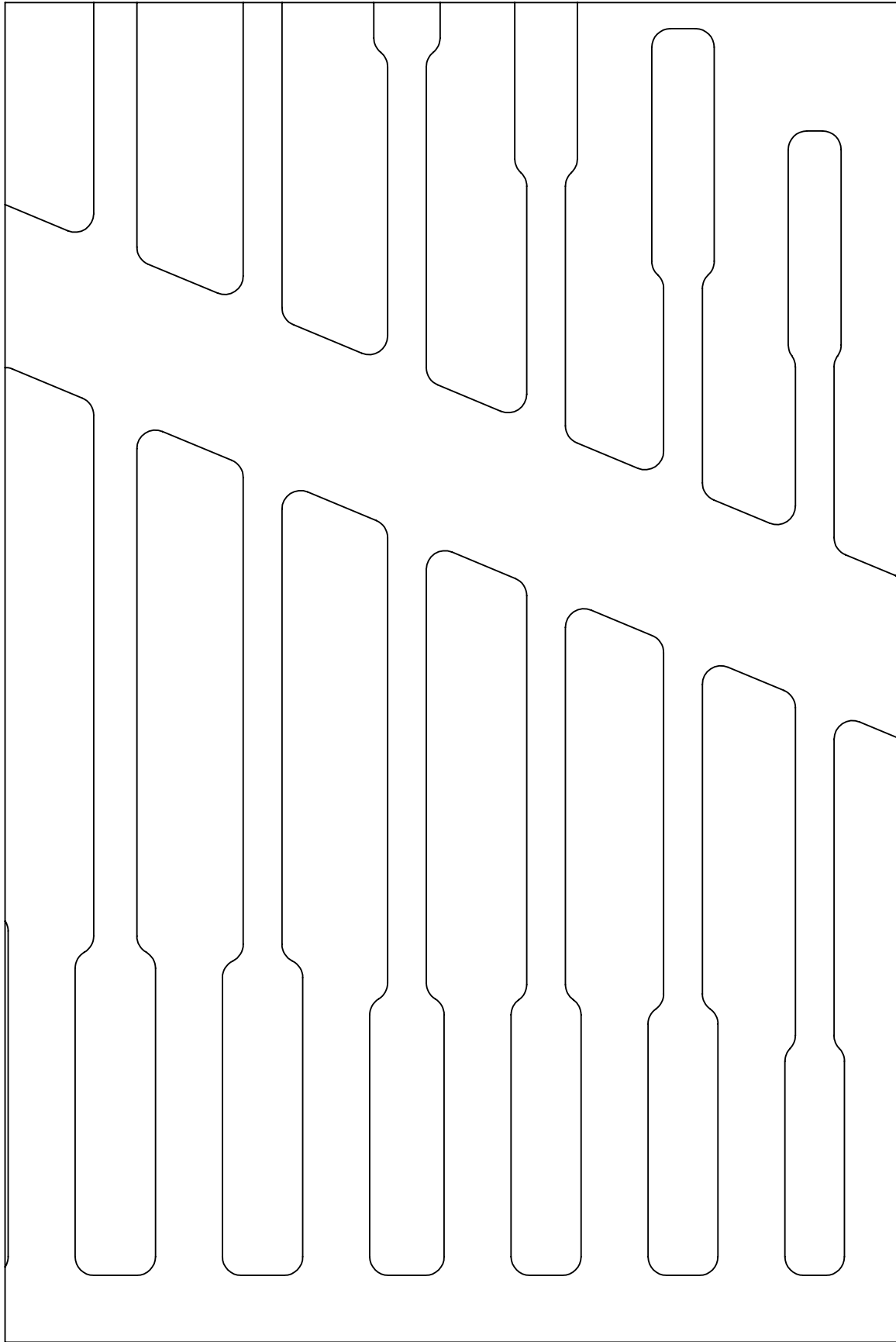

PAGE KEY

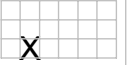

DATE CREATED

19 DEC 2019

PART NUMBER

F-03437-T

Print on Letter at 100%

1.00 IN

1.00 IN

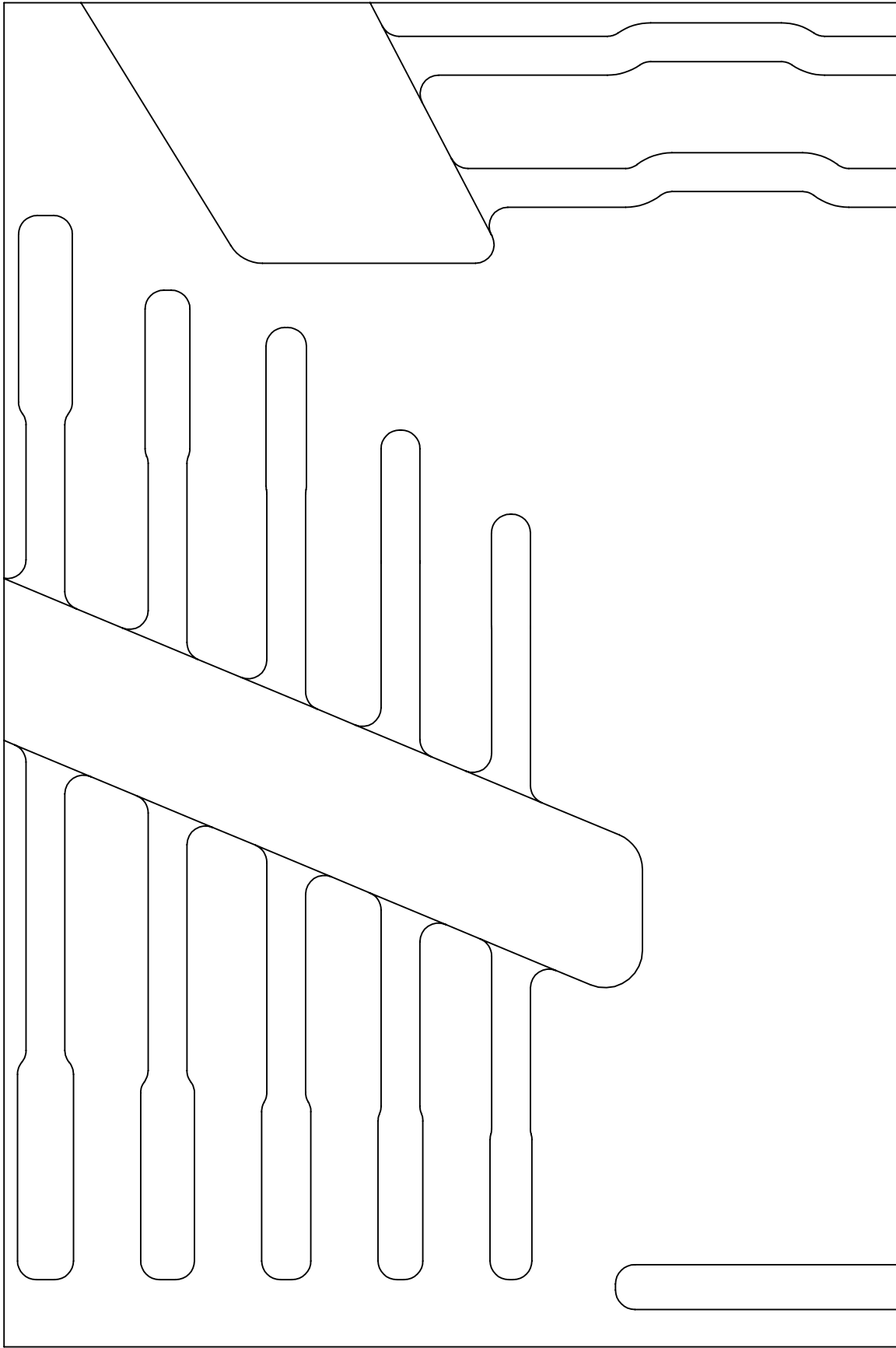

PAGE KEY



DATE CREATED

19 DEC 2019

PART NUMBER

F-03437-T

← 1.00 IN →

PAGE KEY



↑ 1.00 IN ↓

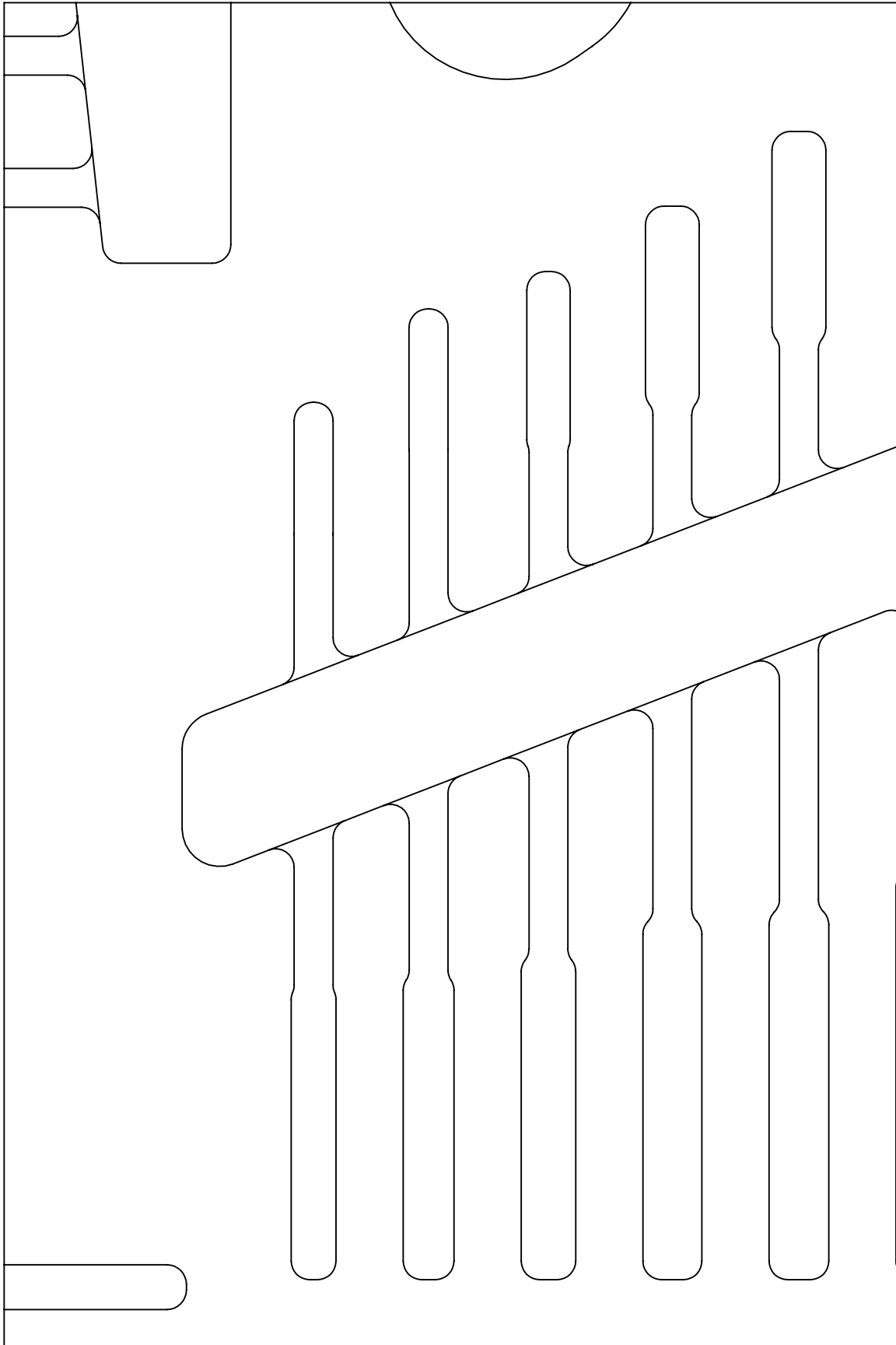

Print on Letter at 100%

DATE CREATED

19 DEC 2019

PART NUMBER

F-03437-T

← 1.00 IN →

PAGE KEY

X									
---	--	--	--	--	--	--	--	--	--

1.00
IN

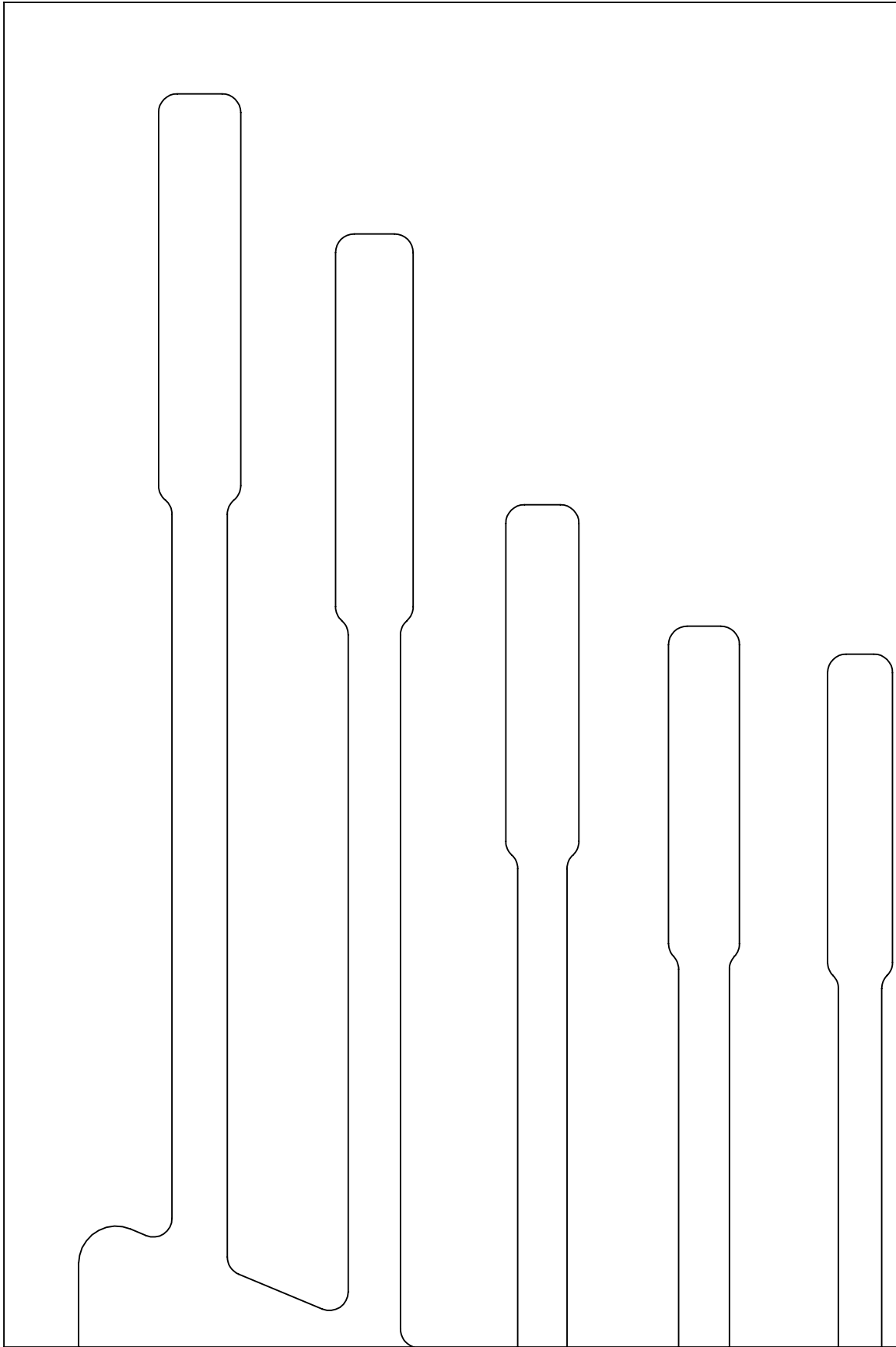

Print on Letter at 100%

DATE CREATED

19 DEC 2019

PART NUMBER

F-03437-T

← 1.00 IN →

PAGE KEY

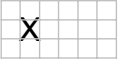

↑ 1.00 IN ↓

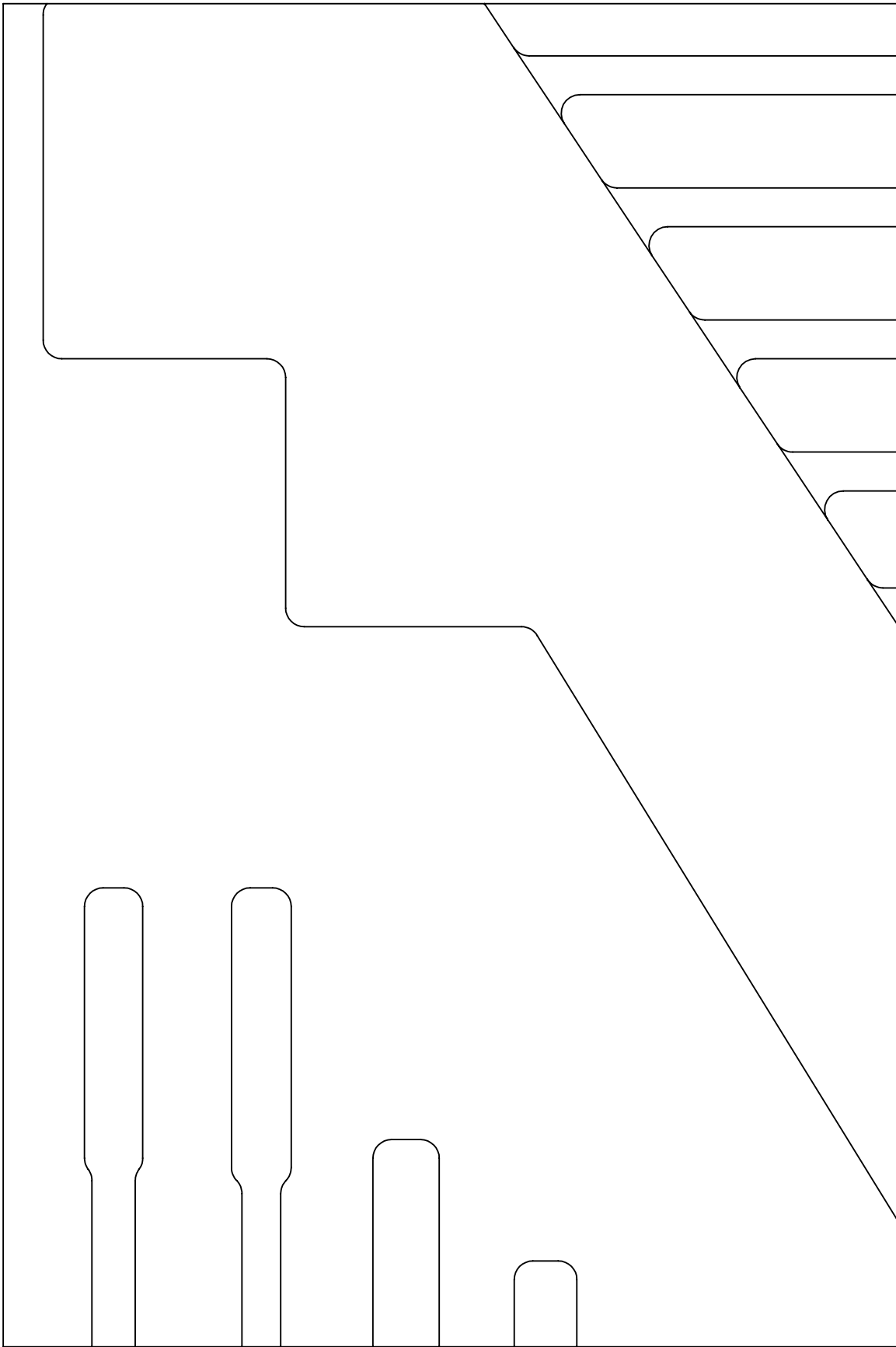

Print on Letter at 100%

DATE CREATED

19 DEC 2019

PART NUMBER

F-03437-T

← 1.00 IN →

PAGE KEY

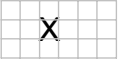

↑ 1.00 IN ↓

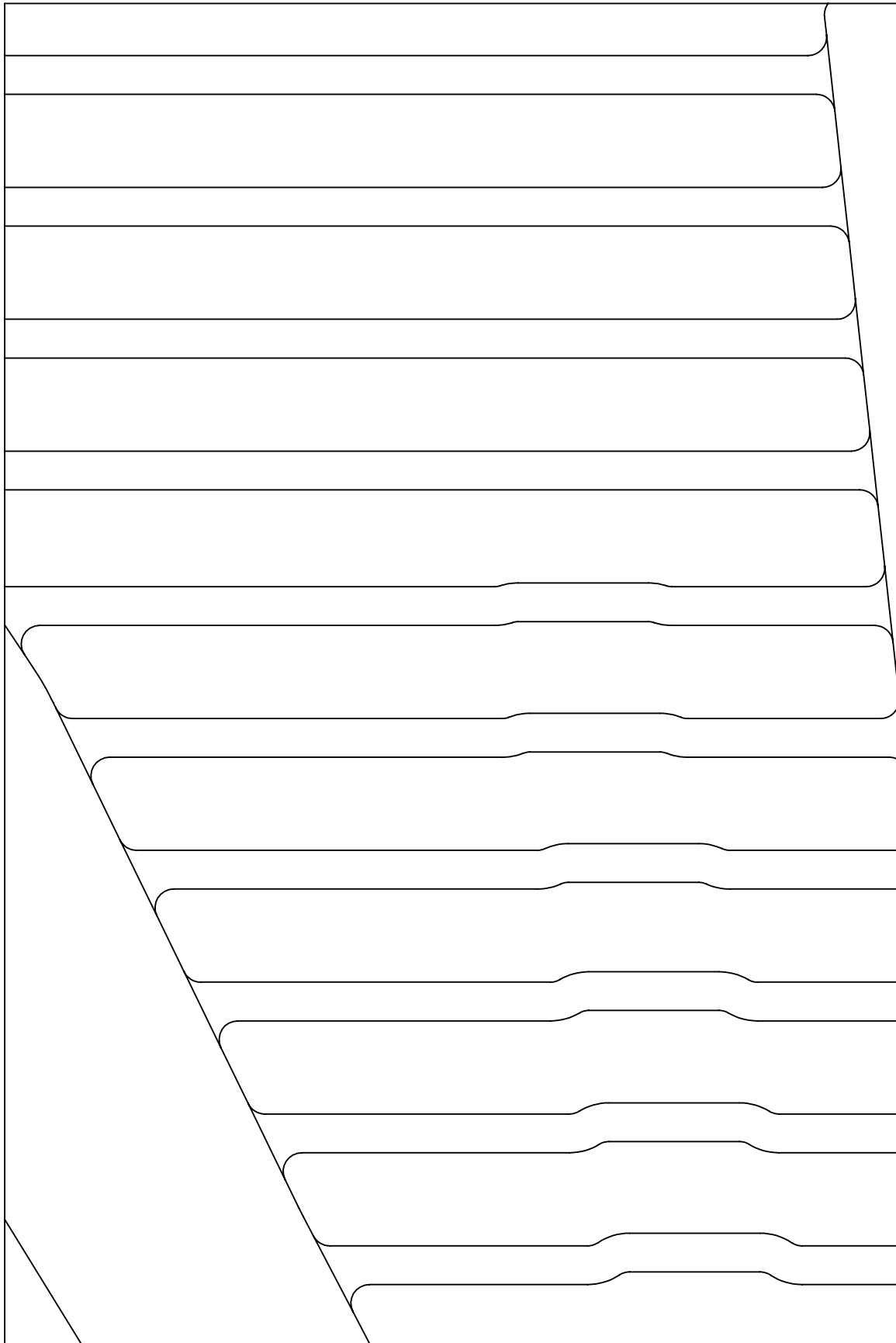

Print on Letter at 100%

DATE CREATED

19 DEC 2019

PART NUMBER

F-03437-T

← 1.00 IN →

PAGE KEY

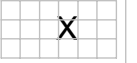

↑ 1.00 IN ↓

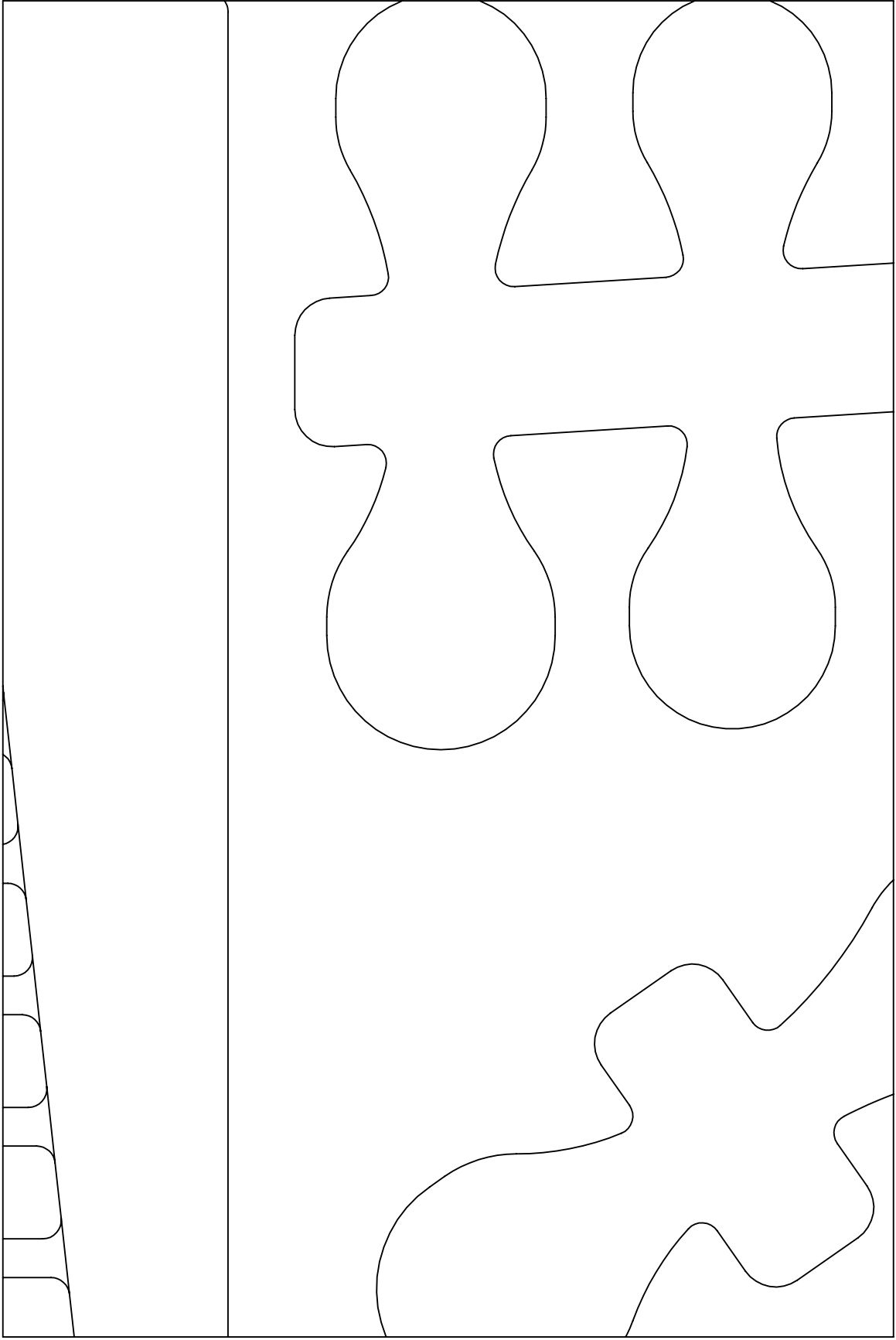

Print on Letter at 100%

DATE CREATED

19 DEC 2019

PART NUMBER

F-03437-T

1.00 IN

PAGE KEY

									X

1.00 IN

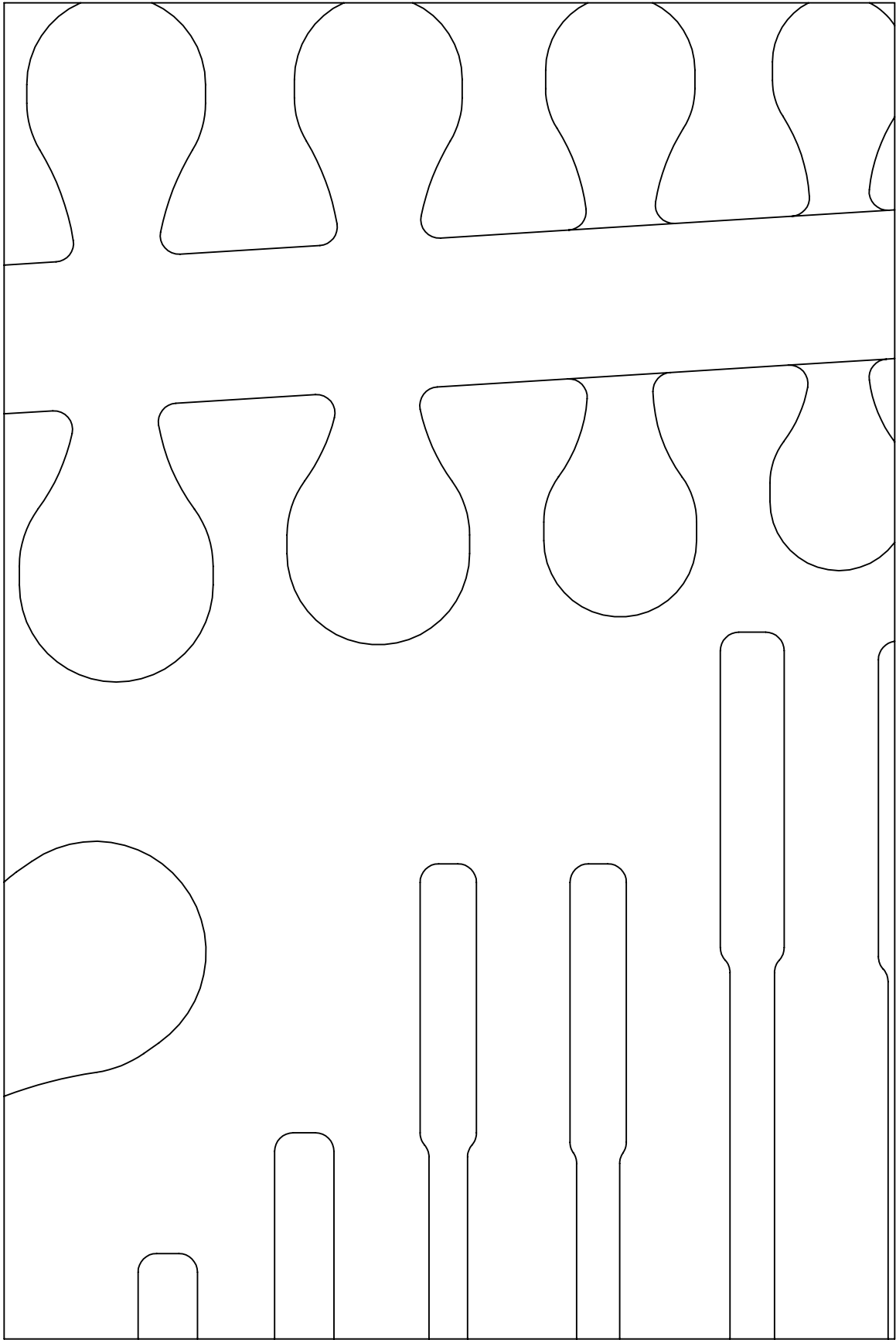

Print on Letter at 100%

DATE CREATED

19 DEC 2019

PART NUMBER

F-03437-T

← 1.00 IN →

PAGE KEY

X									

↑ 1.00 IN ↓

Print on Letter at 100%



PART NUMBER
F-03437-T

DATE CREATED
19 DEC 2019

← 1.00 IN →

PAGE KEY

X									

↑ 1.00 IN ↓

Print on Letter at 100%



DATE CREATED

19 DEC 2019

PART NUMBER

F-03437-T

