

**PRINTING INSTRUCTIONS**

We recommend printing at full-scale to check the fit with your tools before ordering.

**Option 1:** Print this page full-scale on a large-format printer (E-Size, 44 inches X 34 inches).

**Option 2:** Print page 2 - 13 on 8-1/2 X 11 inch paper and assemble.

**Thank You!**

THE INFORMATION CONTAINED ON THIS DRAWING IS THE SOLE PROPERTY OF FOAMFIT TOOLS AND MAY NOT BE USED WITHOUT PERMISSION. Copyright 2023 FoamFit Tools

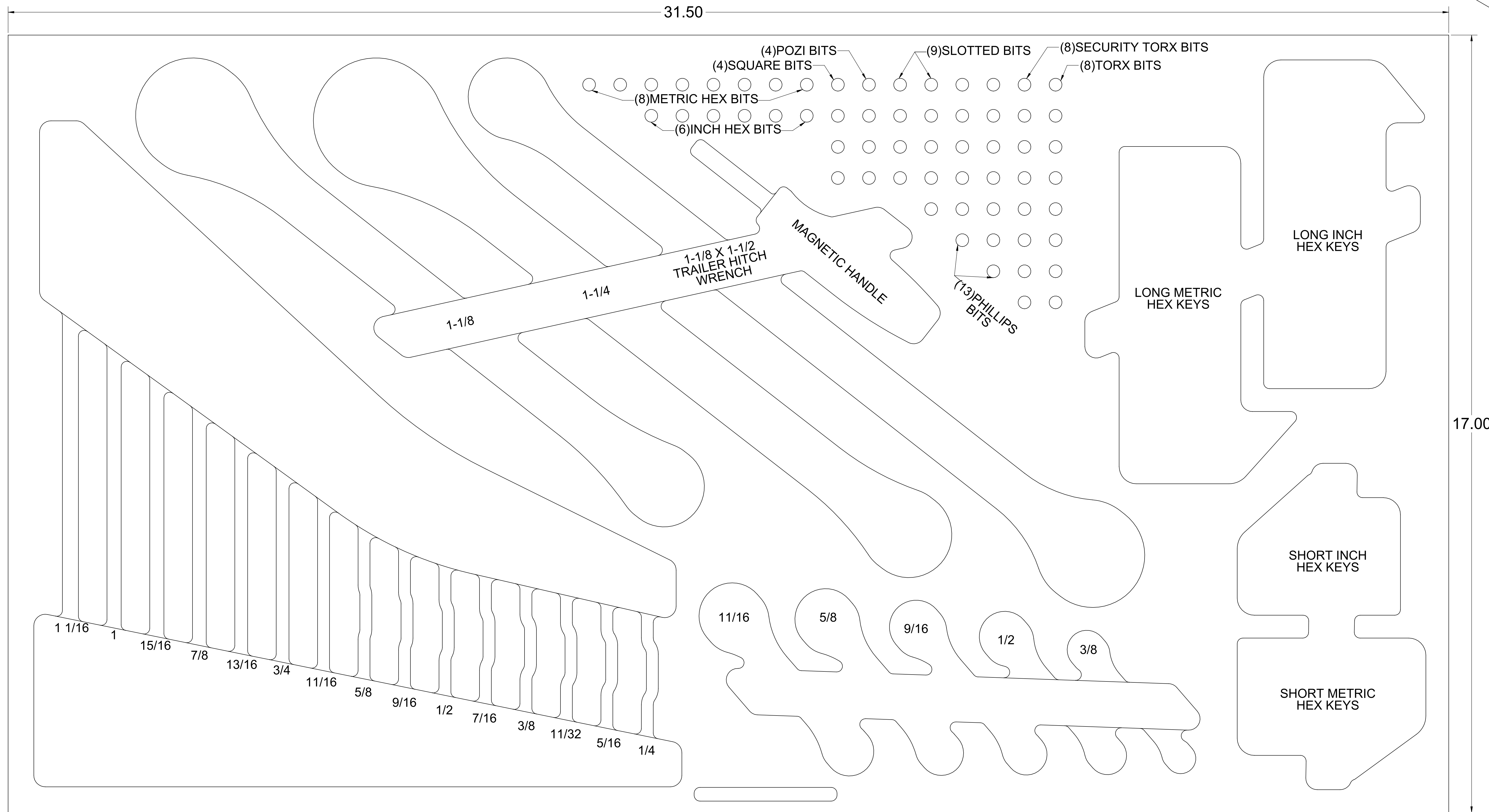
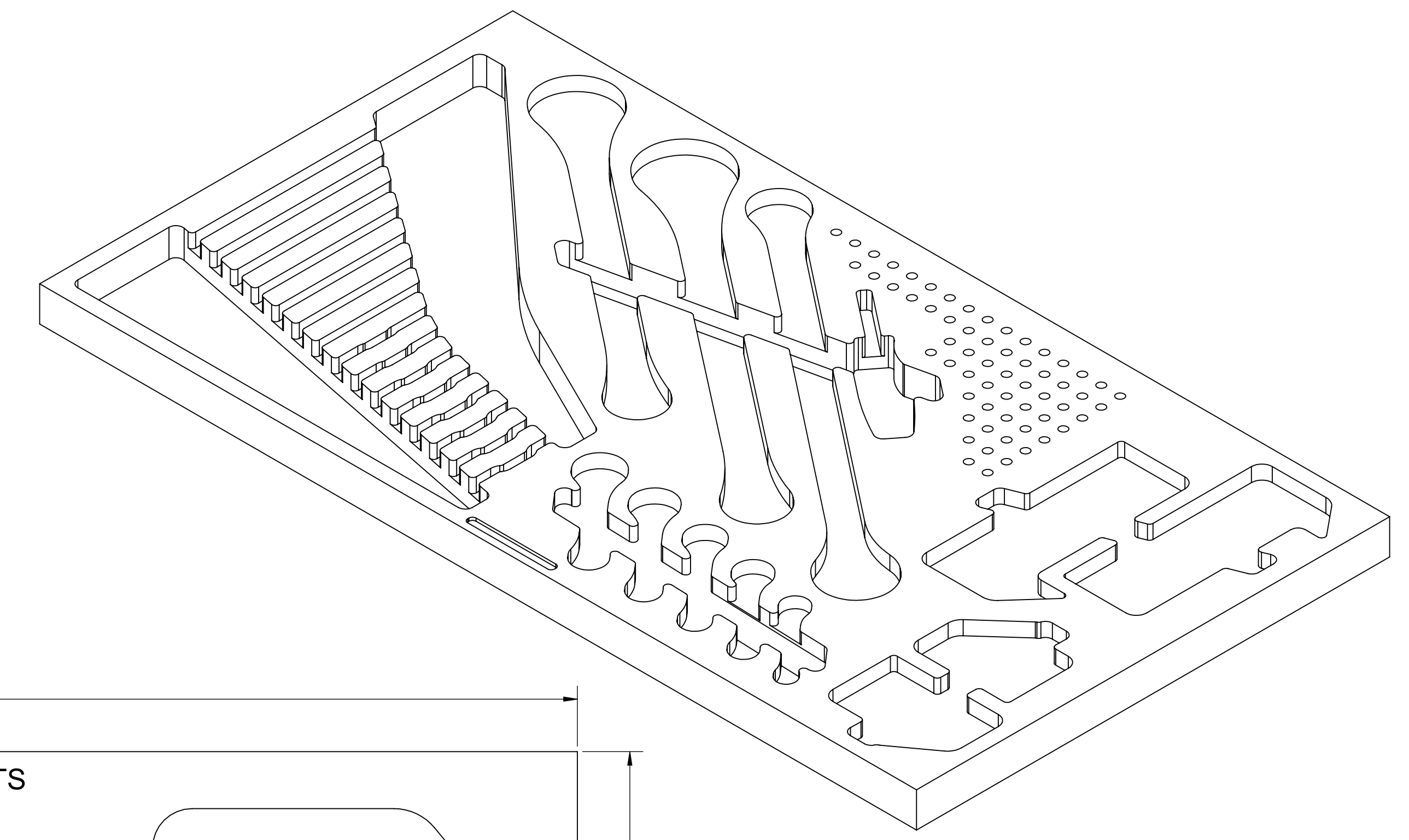

**CAUTION**  
SUGGESTED DRAWER HEIGHT  
2.75 MIN

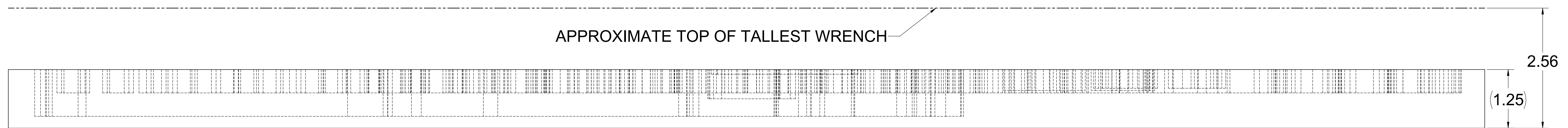

PART NUMBER  
**F-05093-T**

Print on Letter at 100%

← 1.00 IN →

↑ 1.00 IN ↓

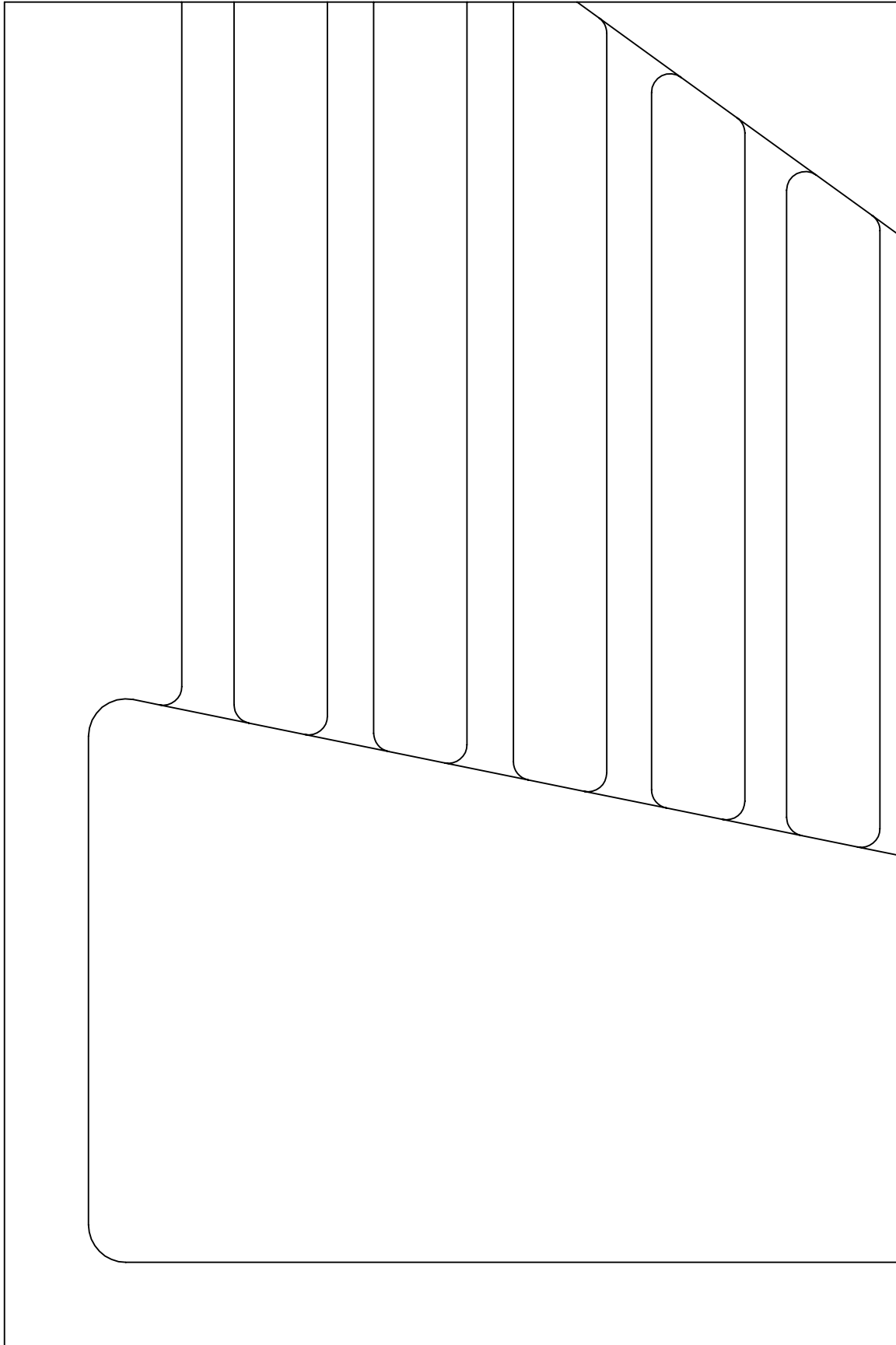

PAGE KEY

X									
---	--	--	--	--	--	--	--	--	--

DATE CREATED

**14 MAR 2023**

PART NUMBER

**F-05093-T**

← 1.00 IN →

PAGE KEY

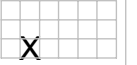

↑ 1.00 IN ↓

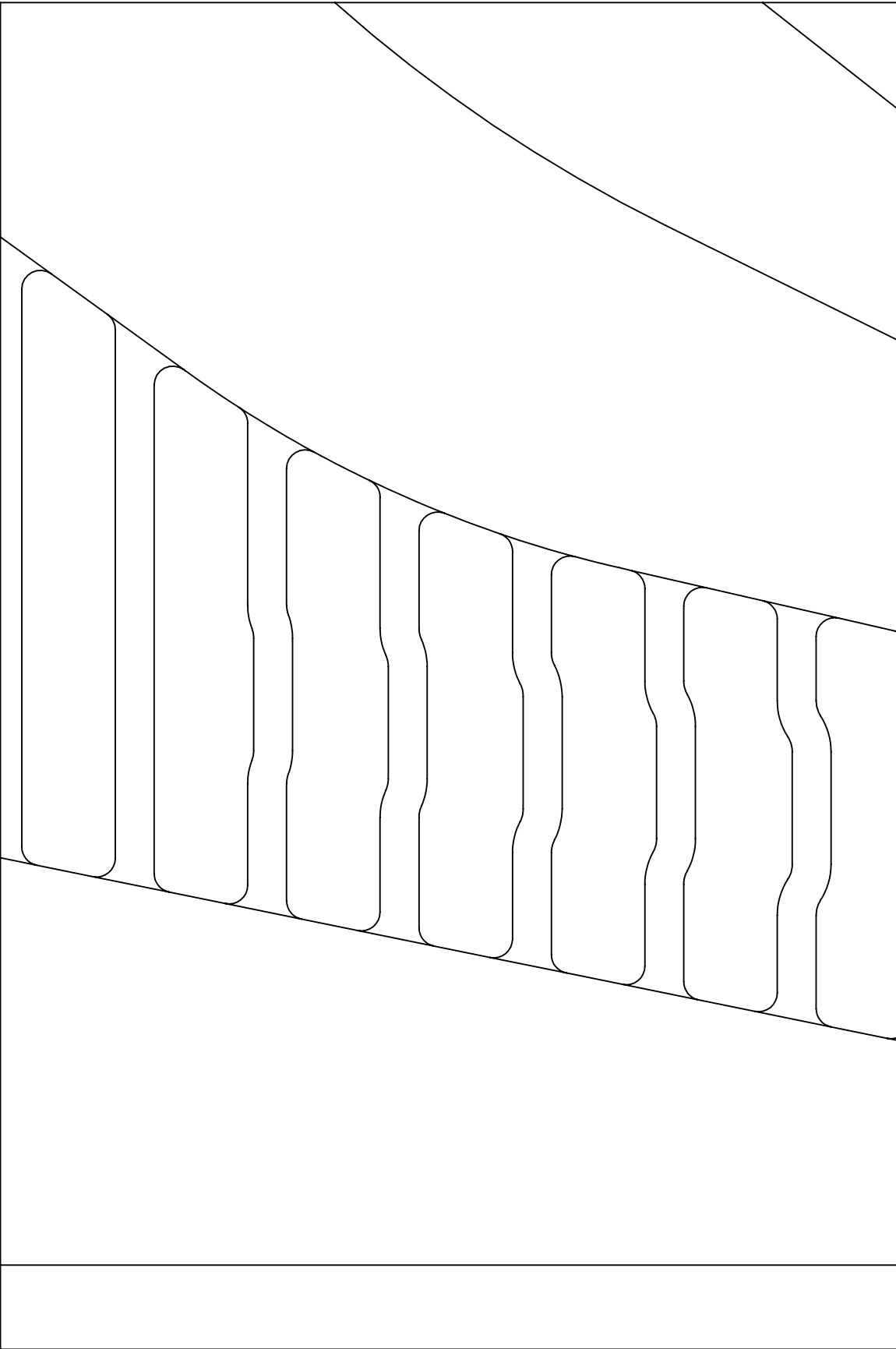

Print on Letter at 100%

DATE CREATED

**14 MAR 2023**

PART NUMBER

**F-05093-T**

Print on Letter at 100%

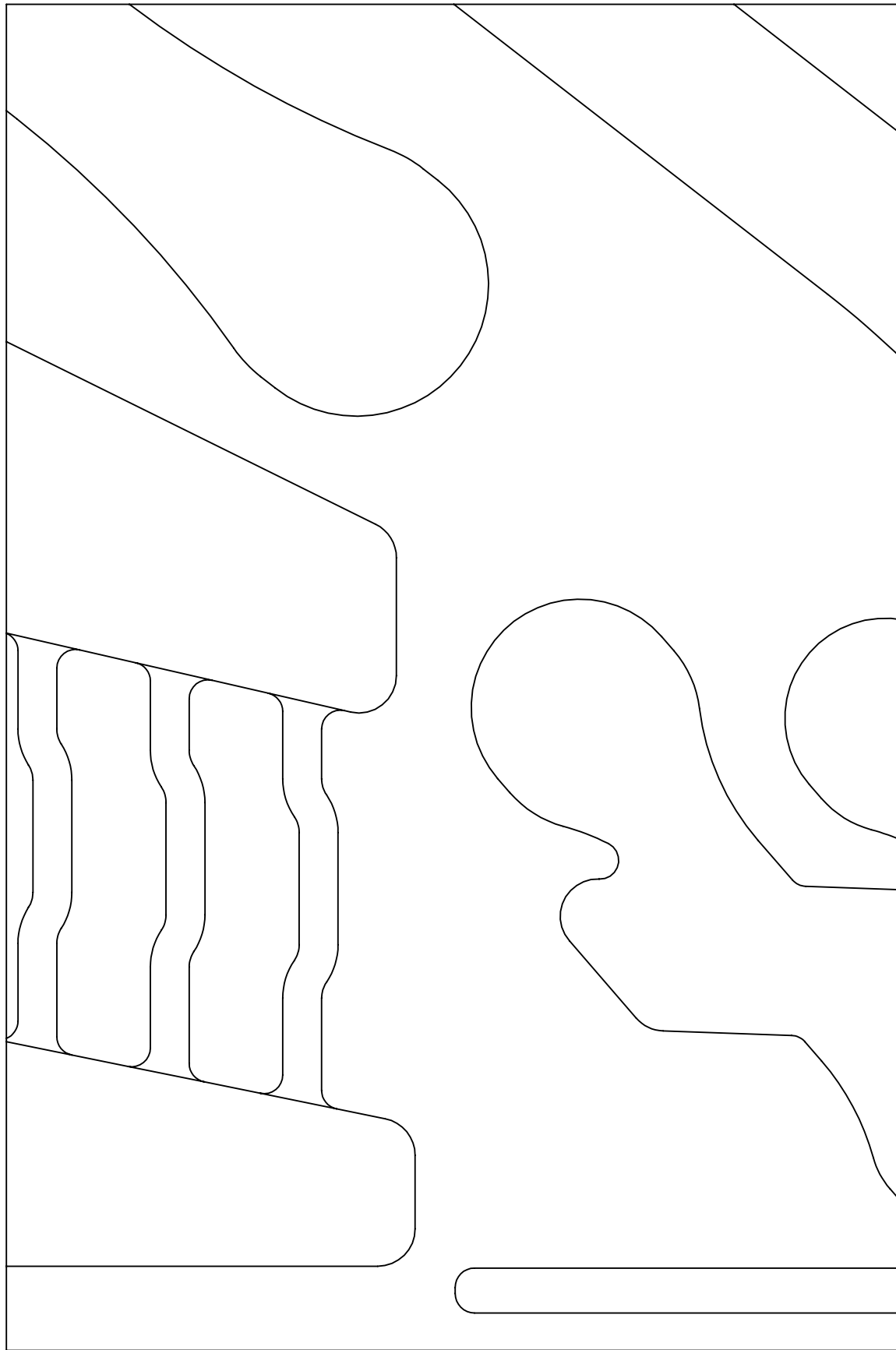

1.00 IN

1.00 IN

PAGE KEY



DATE CREATED

**14 MAR 2023**

PART NUMBER

**F-05093-T**

1.00 IN

PAGE KEY



1.00  
IN

Print on Letter at 100%

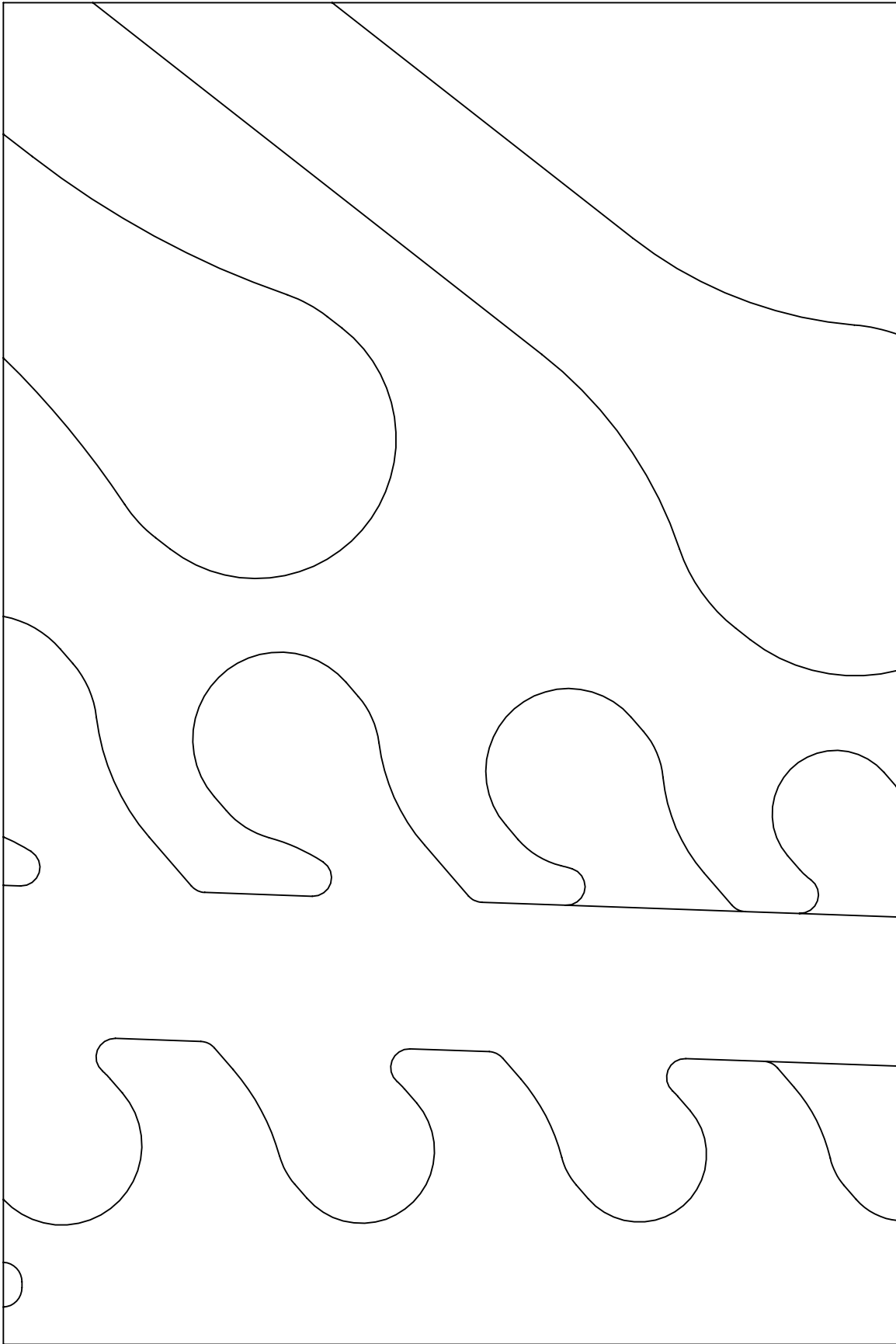

DATE CREATED

**14 MAR 2023**

PART NUMBER

**F-05093-T**





← 1.00 IN →

↑ 1.00 IN ↓

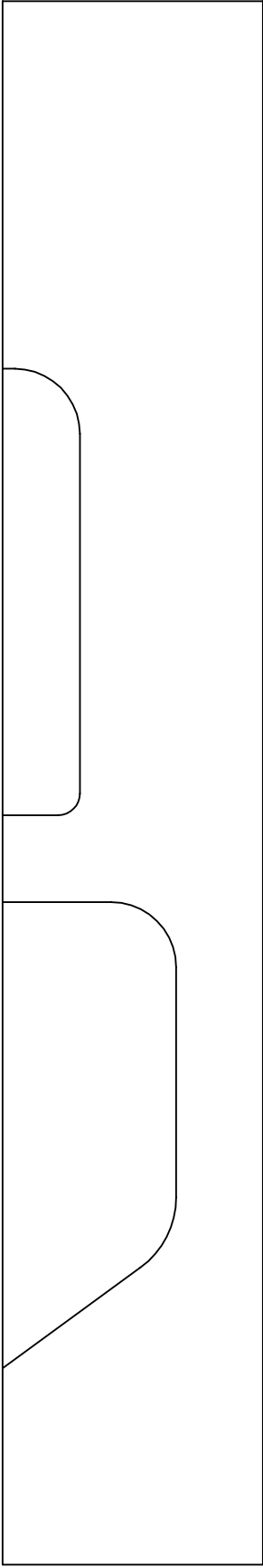

Print on Letter at 100%

PART NUMBER  
**F-05093-T**

DATE CREATED  
**14 MAR 2023**

1.00 IN

PAGE KEY

X									
---	--	--	--	--	--	--	--	--	--

1.00 IN

Print on Letter at 100%

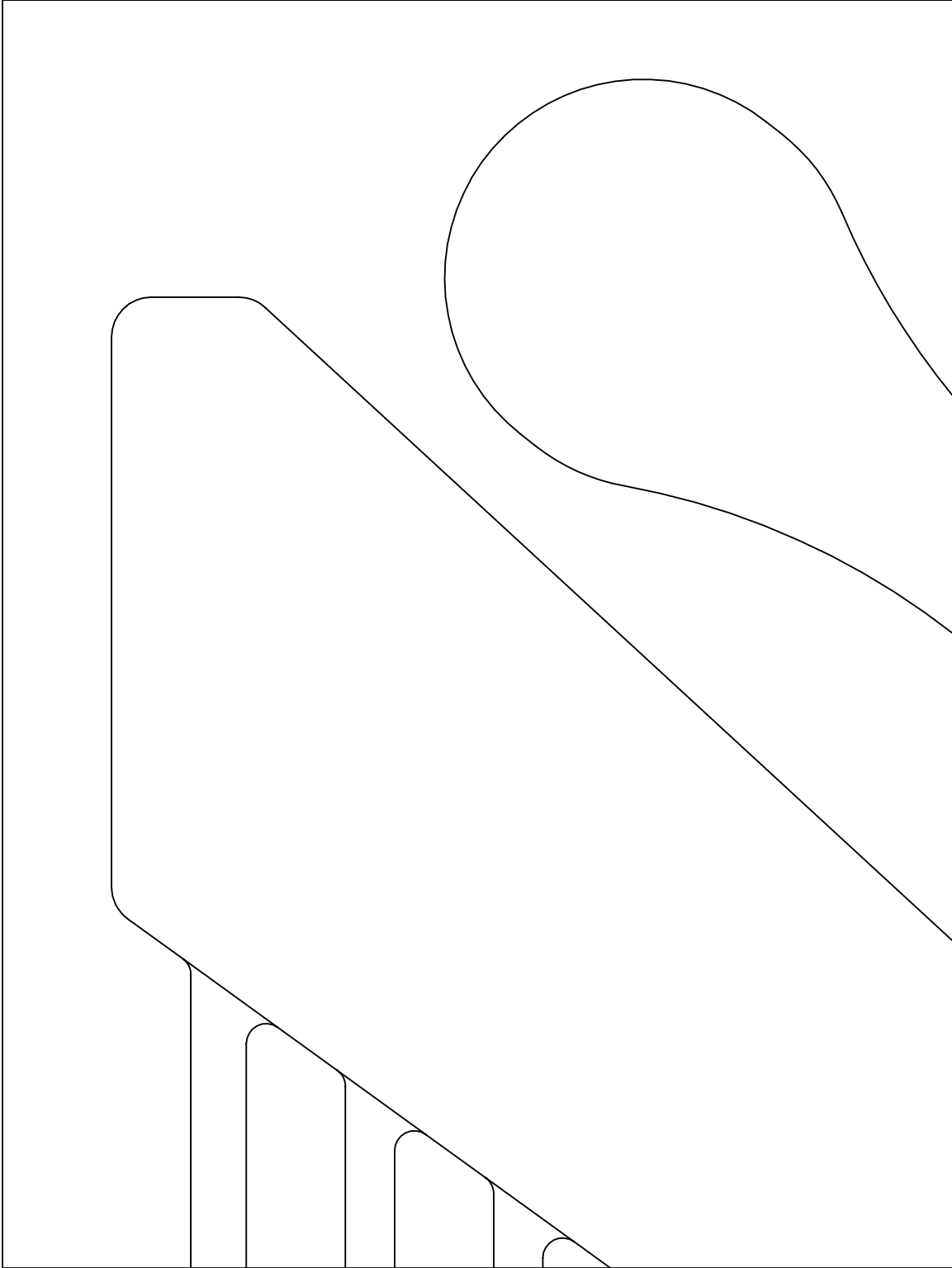

DATE CREATED

**14 MAR 2023**

PART NUMBER

**F-05093-T**



1.00 IN

PAGE KEY

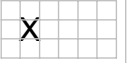

1.00  
IN

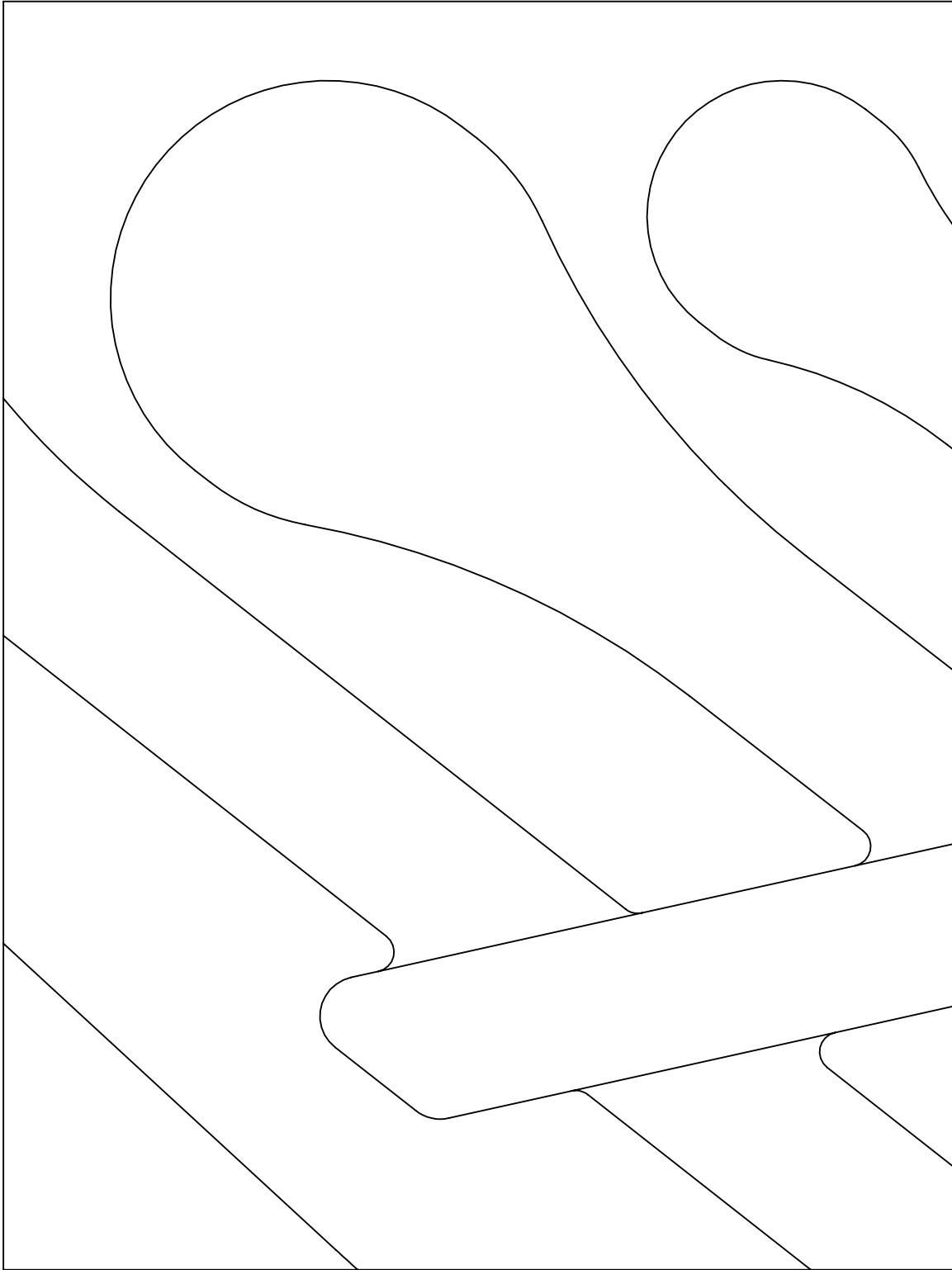

Print on Letter at 100%

DATE CREATED

**14 MAR 2023**

PART NUMBER

**F-05093-T**

1.00 IN

PAGE KEY

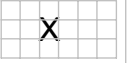

1.00 IN

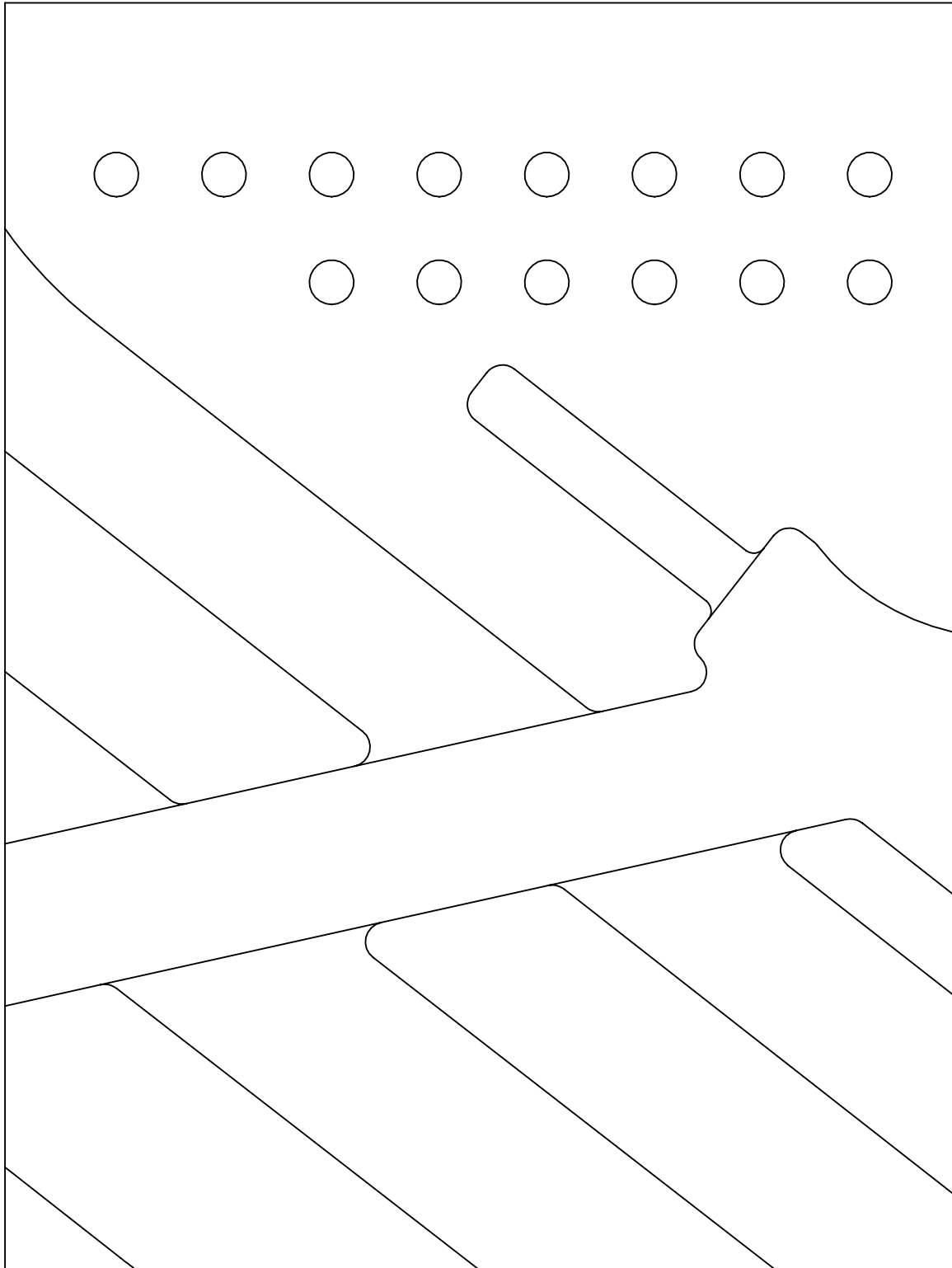

Print on Letter at 100%

DATE CREATED

**14 MAR 2023**

PART NUMBER

**F-05093-T**

1.00 IN

PAGE KEY

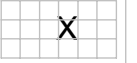

1.00 IN

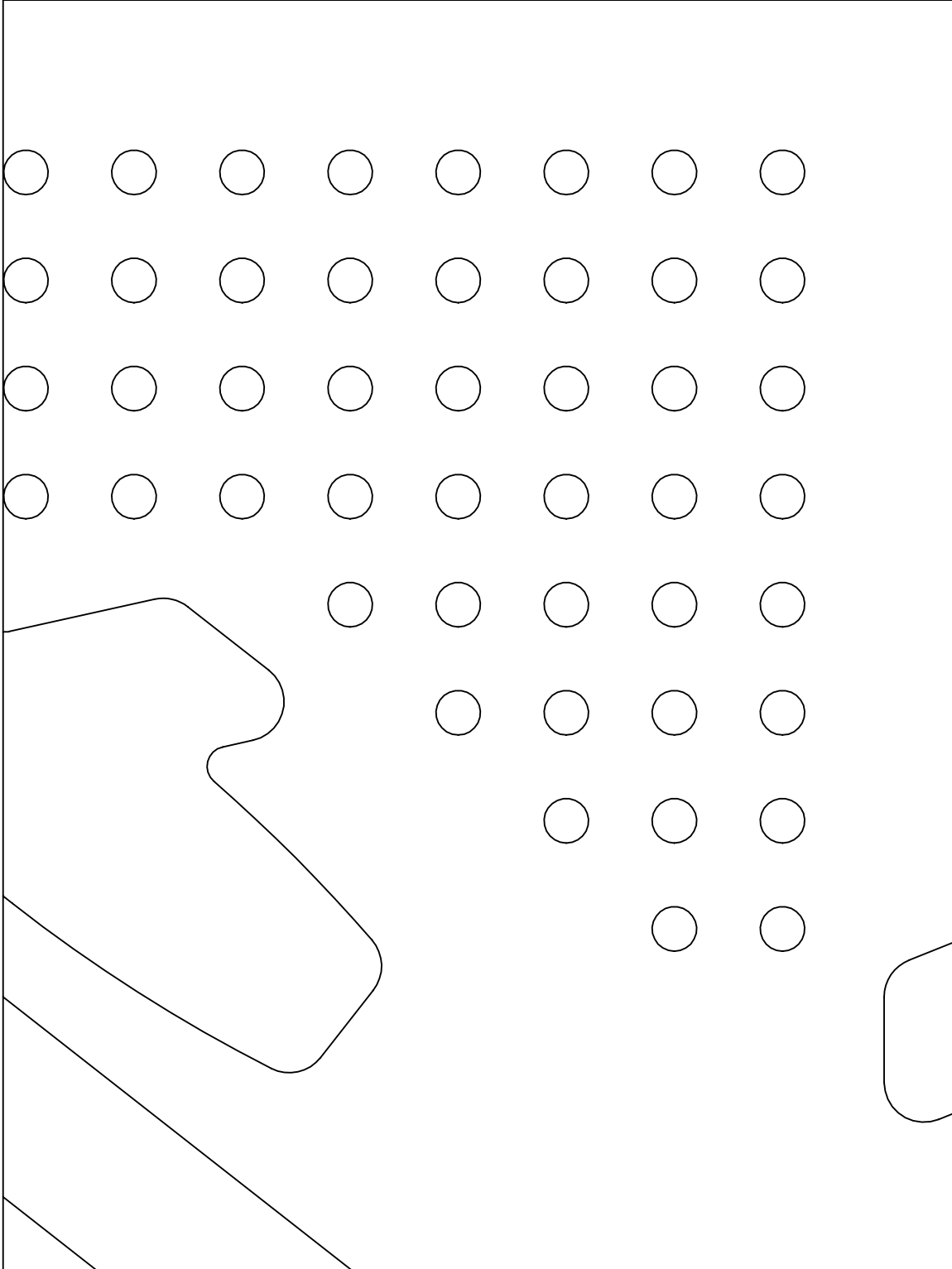

Print on Letter at 100%

DATE CREATED

**14 MAR 2023**

PART NUMBER

**F-05093-T**

1.00 IN

PAGE KEY

									X

1.00 IN

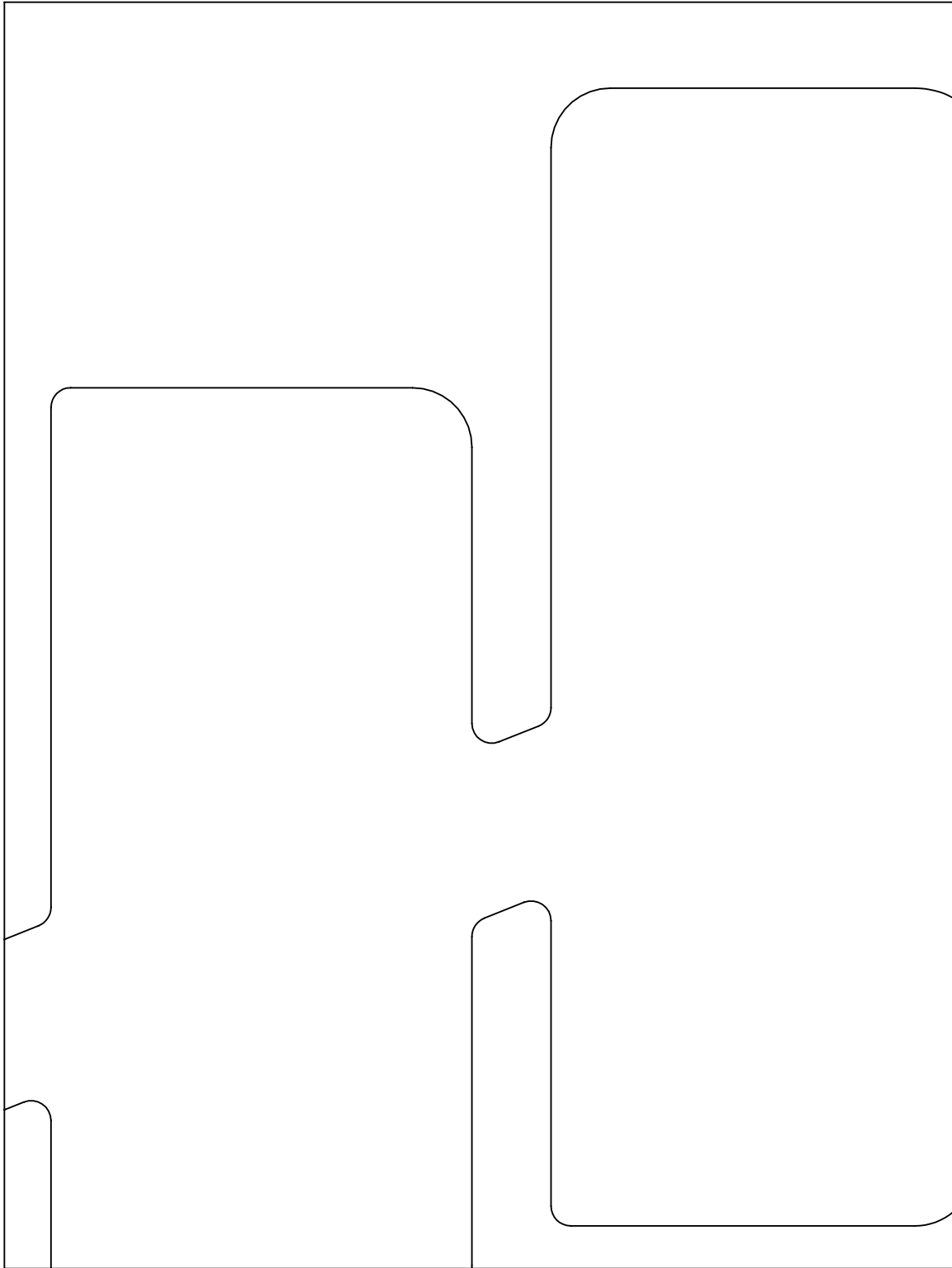

Print on Letter at 100%

DATE CREATED

**14 MAR 2023**

PART NUMBER

**F-05093-T**

