

PRINTING INSTRUCTIONS

We recommend printing at full-scale to check the fit with your tools before ordering.

Option 1: Print this page full-scale on a large-format printer (E-Size, 44 inches X 34 inches).

Option 2: Print page 2 - 13 on 8-1/2 X 11 inch paper and assemble.

Thank You!

THE INFORMATION CONTAINED ON THIS DRAWING IS THE SOLE PROPERTY OF FOAMFIT TOOLS AND MAY NOT BE USED WITHOUT PERMISSION. Copyright 2023 FoamFit Tools

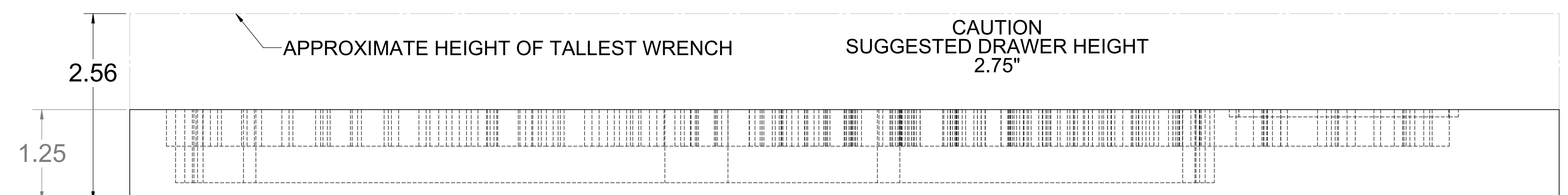
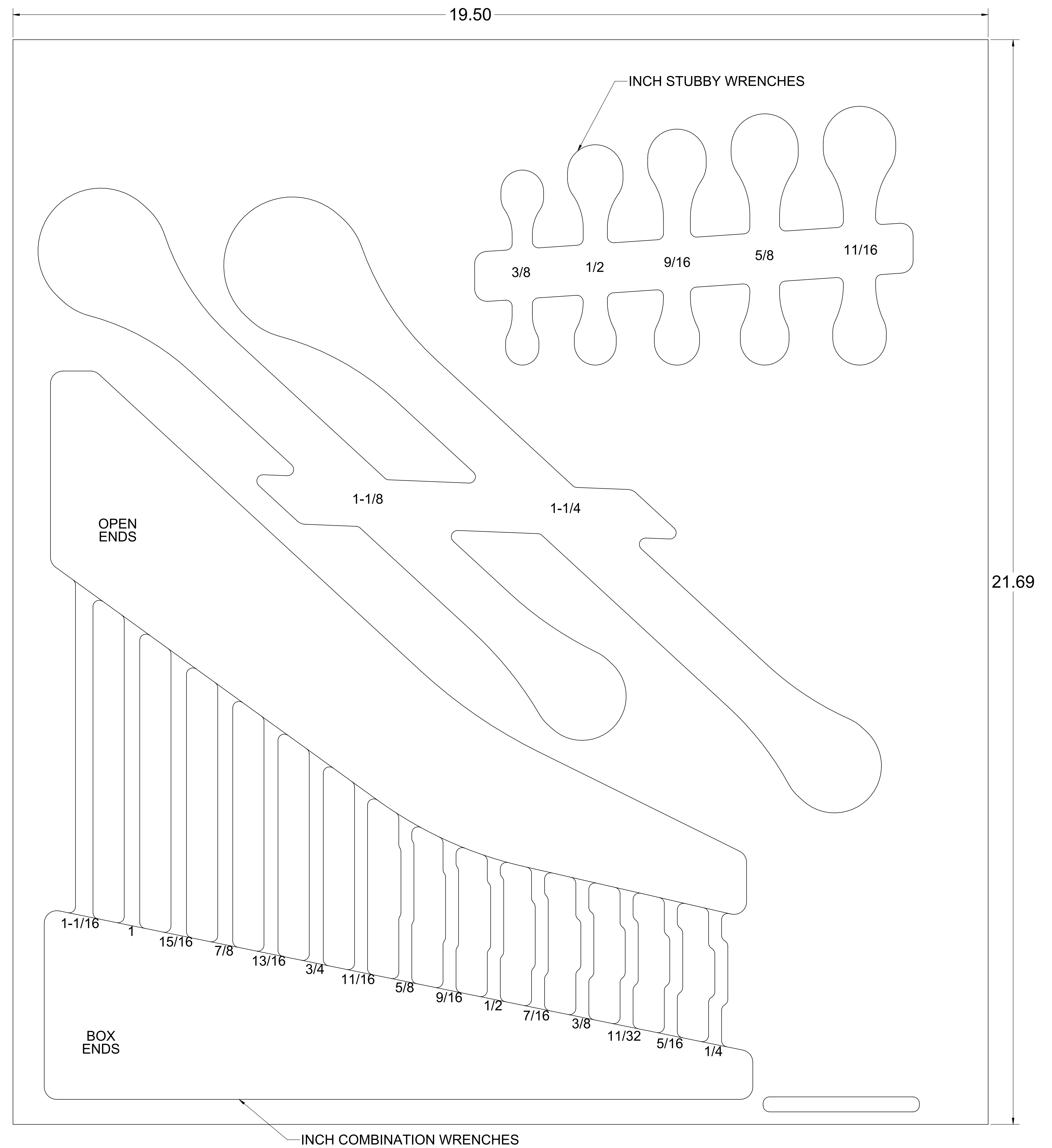
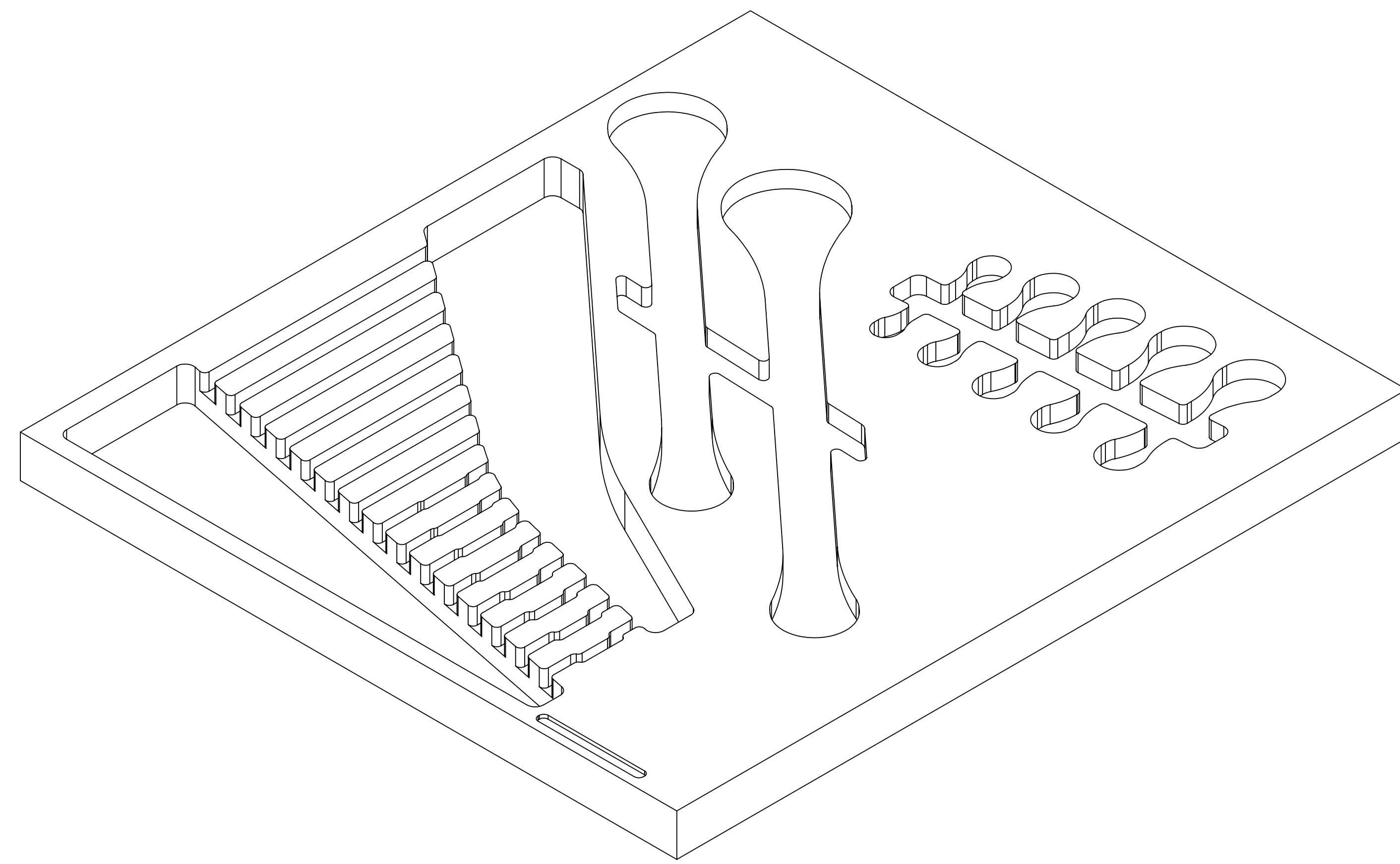

PART NUMBER **F-04700-T**

Print on Letter at 100%

1.00
IN

1.00 IN

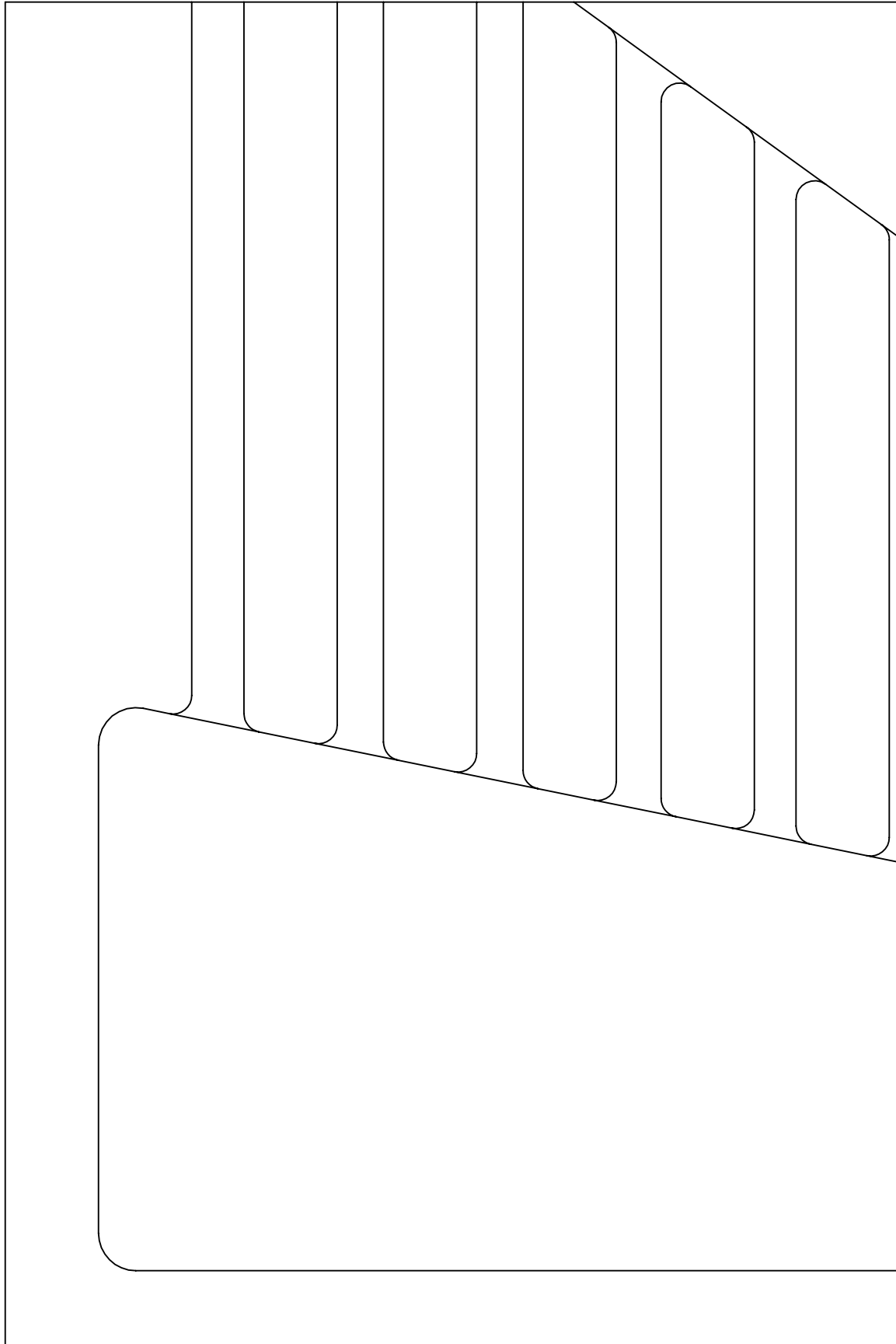

PAGE KEY

X									
---	--	--	--	--	--	--	--	--	--

DATE CREATED

02 MAY 2022

PART NUMBER

F-04700-T

← 1.00 IN →

PAGE KEY

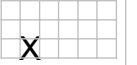

↑ 1.00 IN ↓

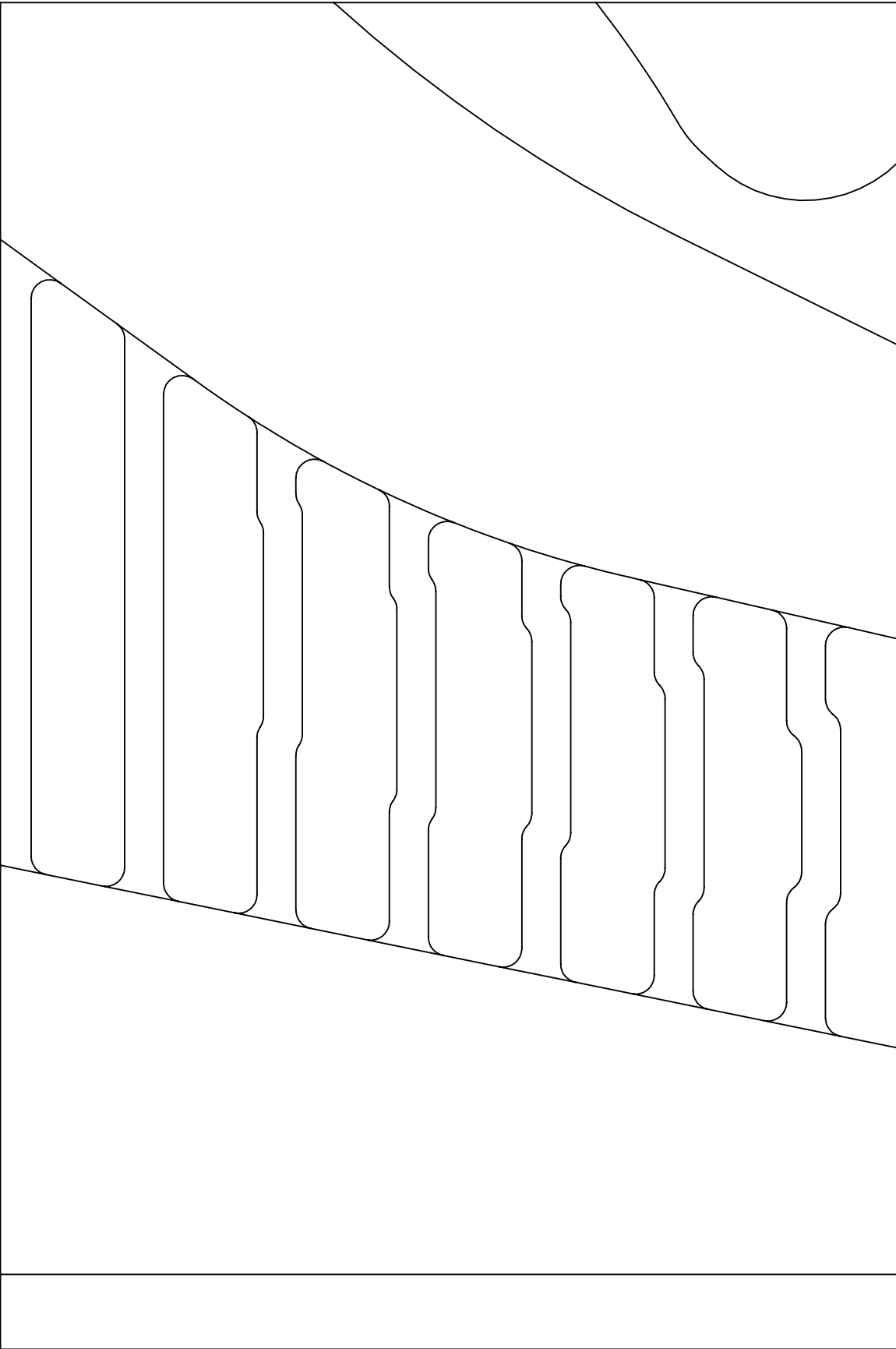

Print on Letter at 100%

DATE CREATED

02 MAY 2022

PART NUMBER

F-04700-T

1.00 IN

1.00 IN

PAGE KEY



Print on Letter at 100%

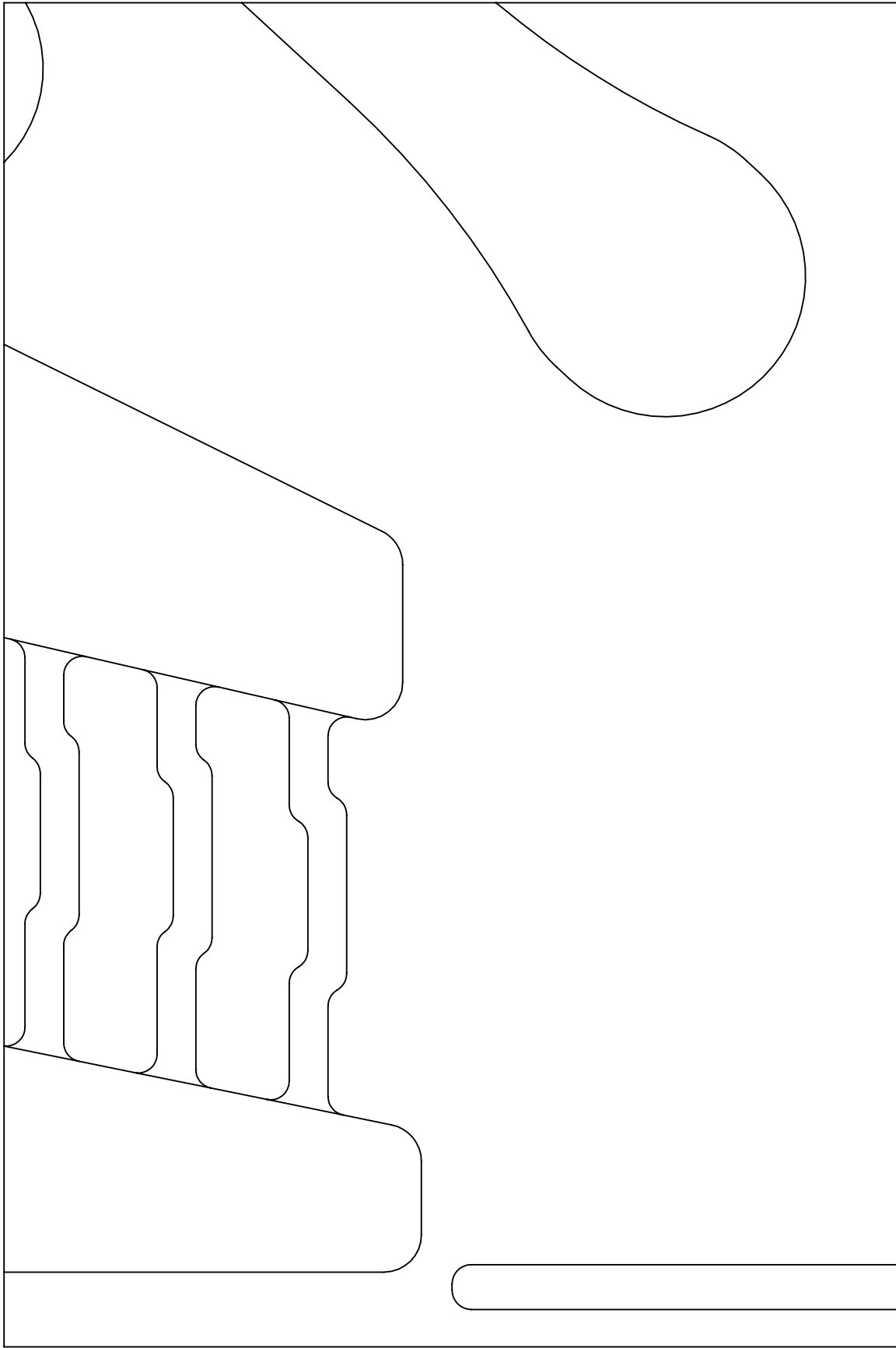

PART NUMBER
F-04700-T

DATE CREATED
02 MAY 2022



1.00 IN

1.00 IN

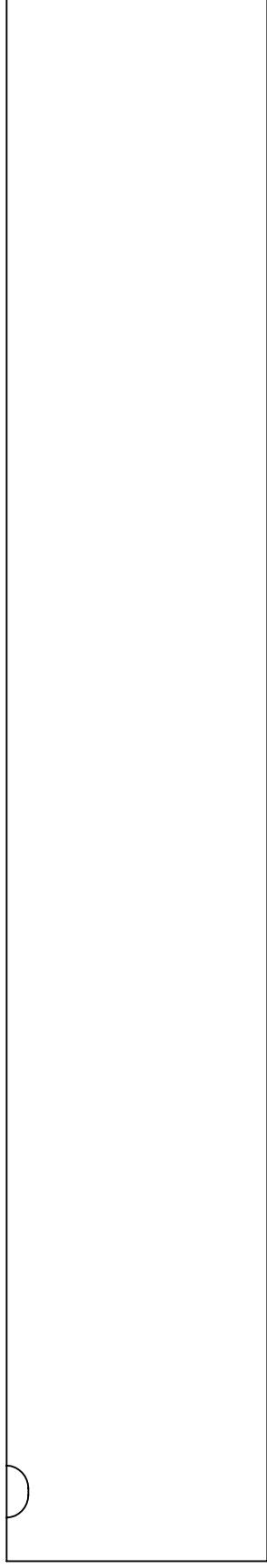

Print on Letter at 100%

PART NUMBER	DATE CREATED
F-04700-T	02 MAY 2022

← 1.00 IN →

PAGE KEY

X									
---	--	--	--	--	--	--	--	--	--

↑ 1.00 IN ↓

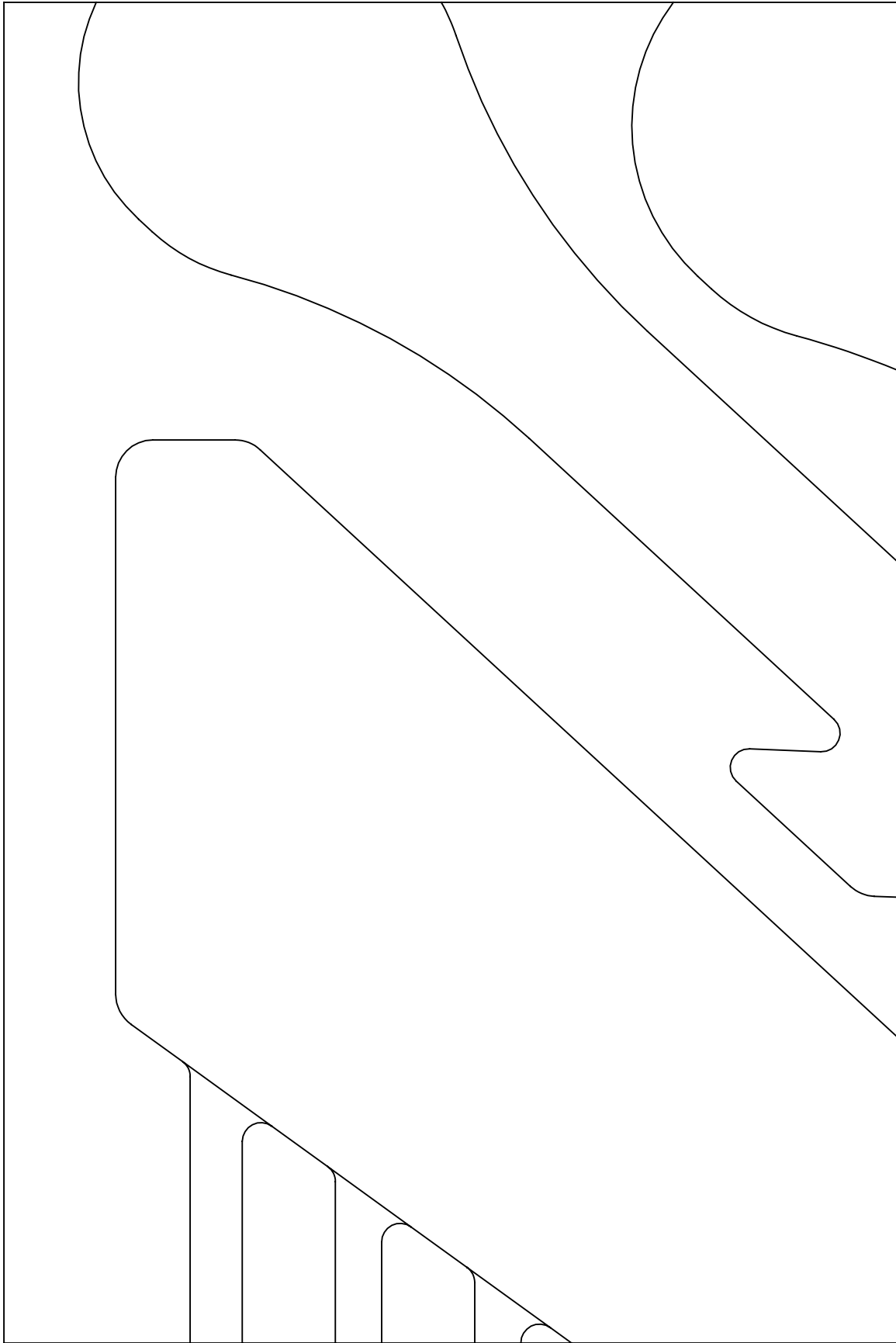

Print on Letter at 100%

PART NUMBER **F-04700-T**
DATE CREATED **02 MAY 2022**

1.00 IN

PAGE KEY

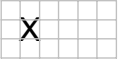

1.00
IN

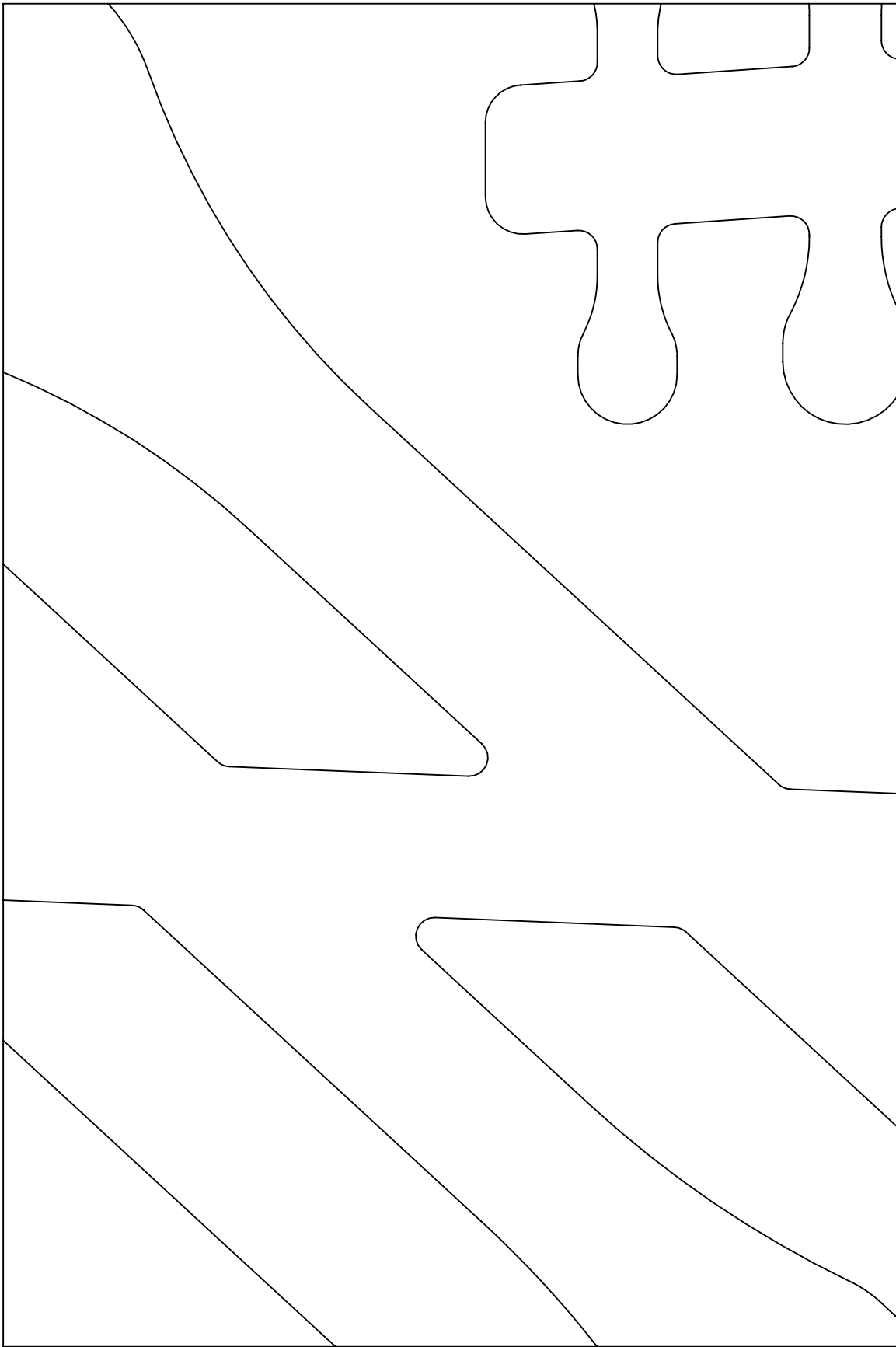

Print on Letter at 100%

DATE CREATED

02 MAY 2022

PART NUMBER

F-04700-T

1.00 IN

1.00 IN

PAGE KEY

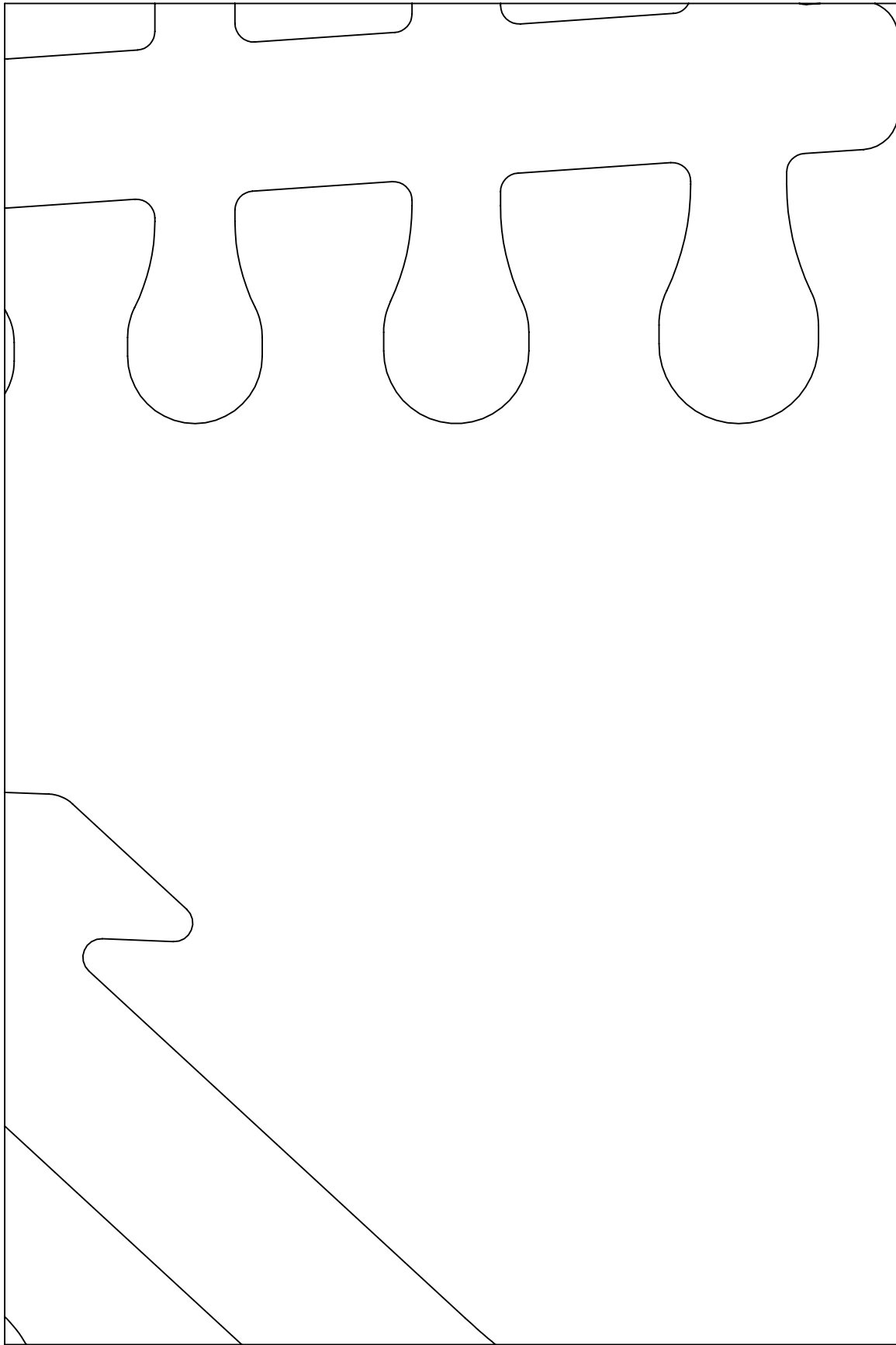
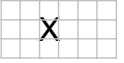

Print on Letter at 100%

DATE CREATED

02 MAY 2022

PART NUMBER

F-04700-T

1.00 IN

PAGE KEY

X									

1.00
IN

DATE CREATED
02 MAY 2022

PART NUMBER
F-04700-T

Print on Letter at 100%

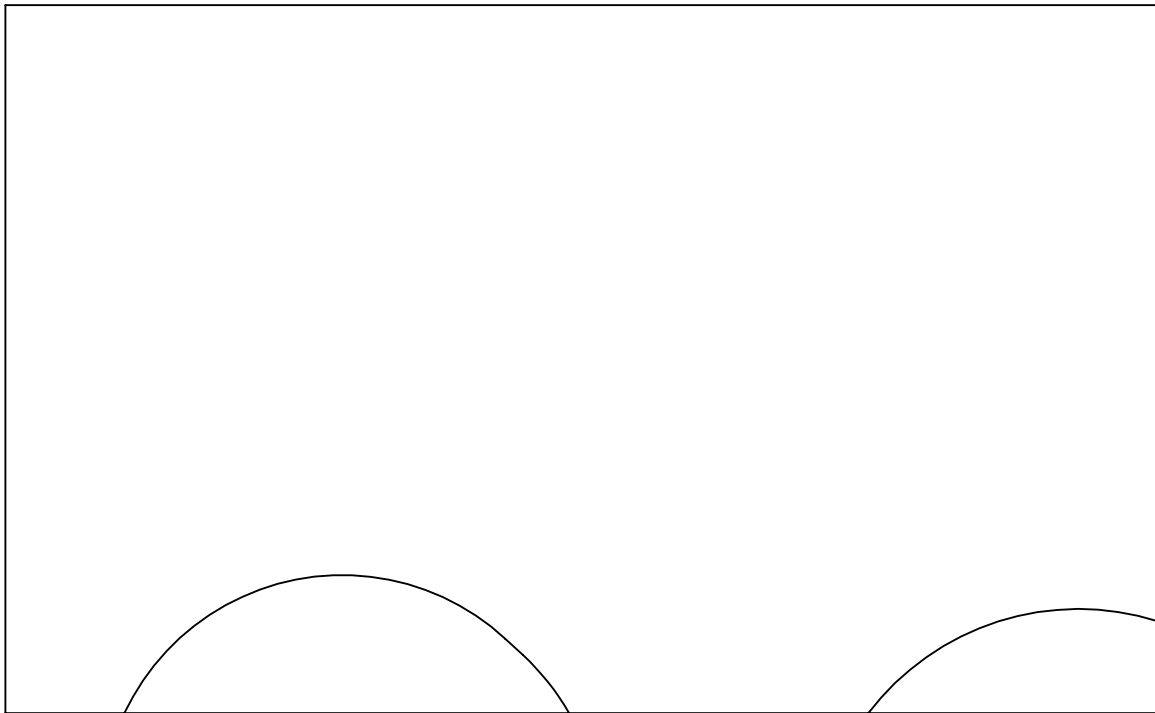

1.00 IN

PAGE KEY

X									

1.00
IN

DATE CREATED
02 MAY 2022

PART NUMBER
F-04700-T

Print on Letter at 100%

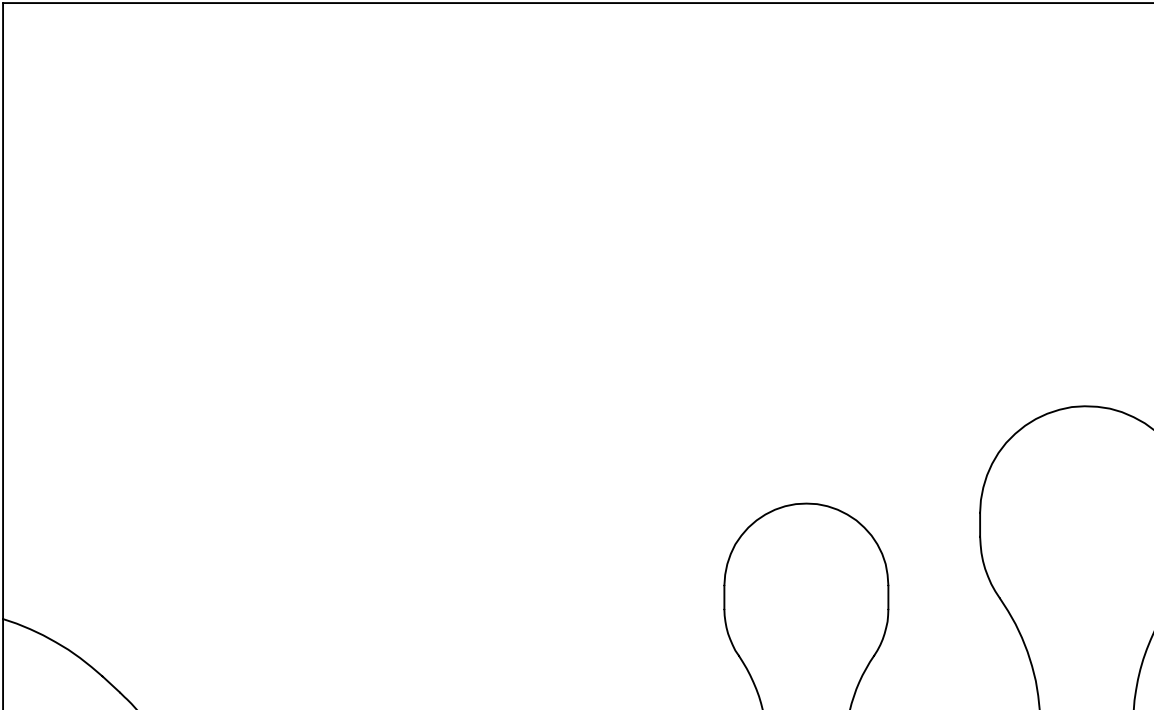

1.00 IN

PAGE KEY



1.00
IN

DATE CREATED
02 MAY 2022

PART NUMBER
F-04700-T

Print on Letter at 100%

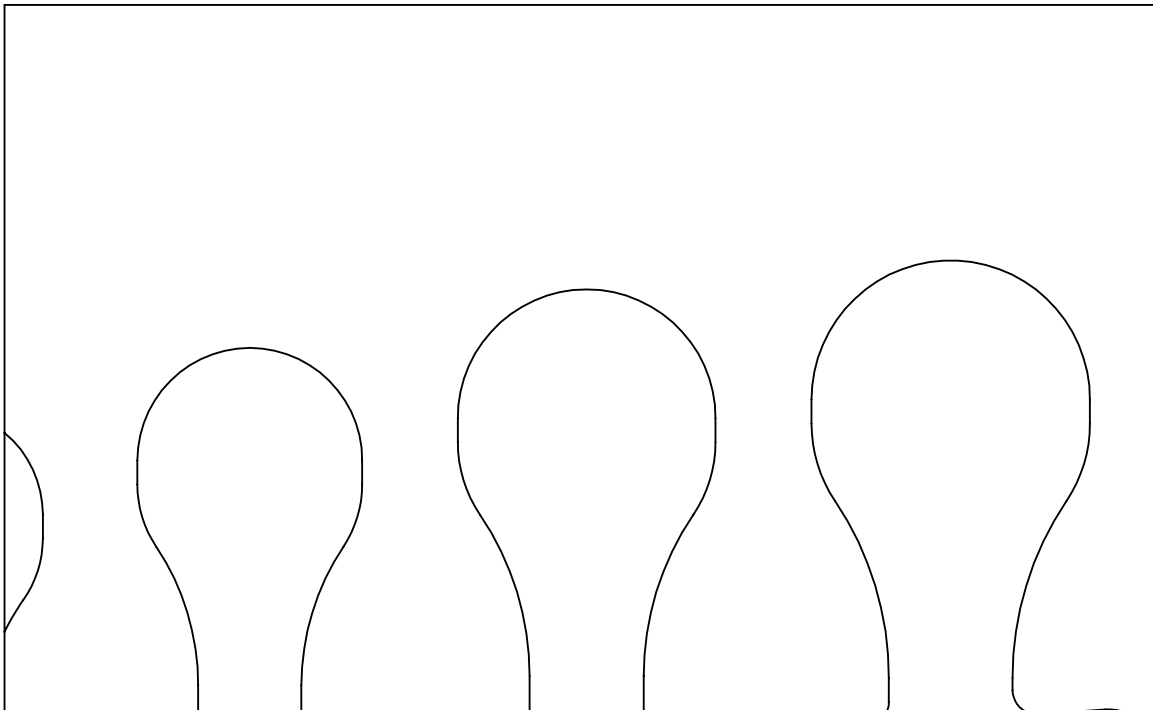

1.00 IN

PAGE KEY



1.00
IN

Print on Letter at 100%

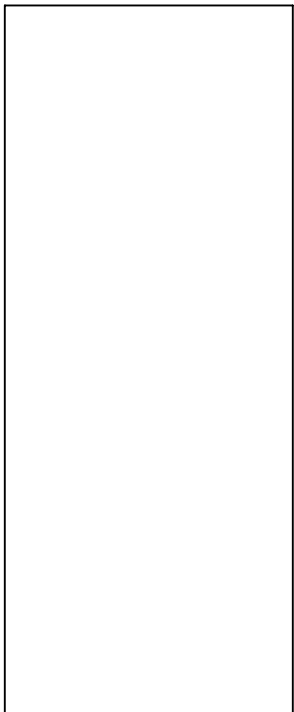

DATE CREATED

02 MAY 2022

PART NUMBER

F-04700-T