

**PRINTING INSTRUCTIONS**

We recommend printing at full-scale to check the fit with your tools before ordering.

**Option 1:** Print this page full-scale on a large-format printer (E-Size, 44 inches X 34 inches).

**Option 2:** Print page 2 - 19 on 8-1/2 X 11 inch paper and assemble.

**Thank You!**

THE INFORMATION CONTAINED ON THIS DRAWING IS THE SOLE PROPERTY OF FOAMFIT TOOLS AND MAY NOT BE USED WITHOUT PERMISSION. Copyright 2021 FoamFit Tools

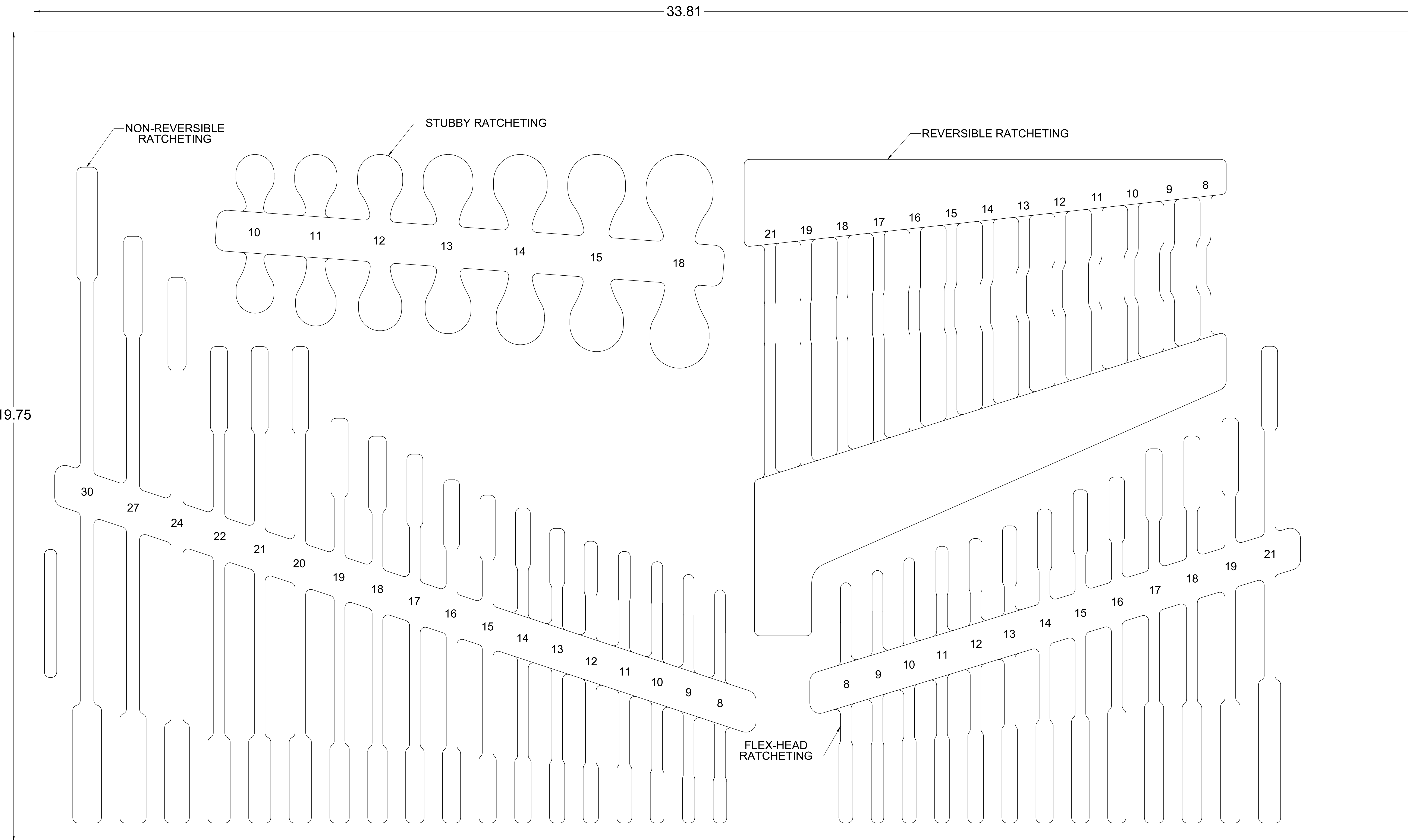
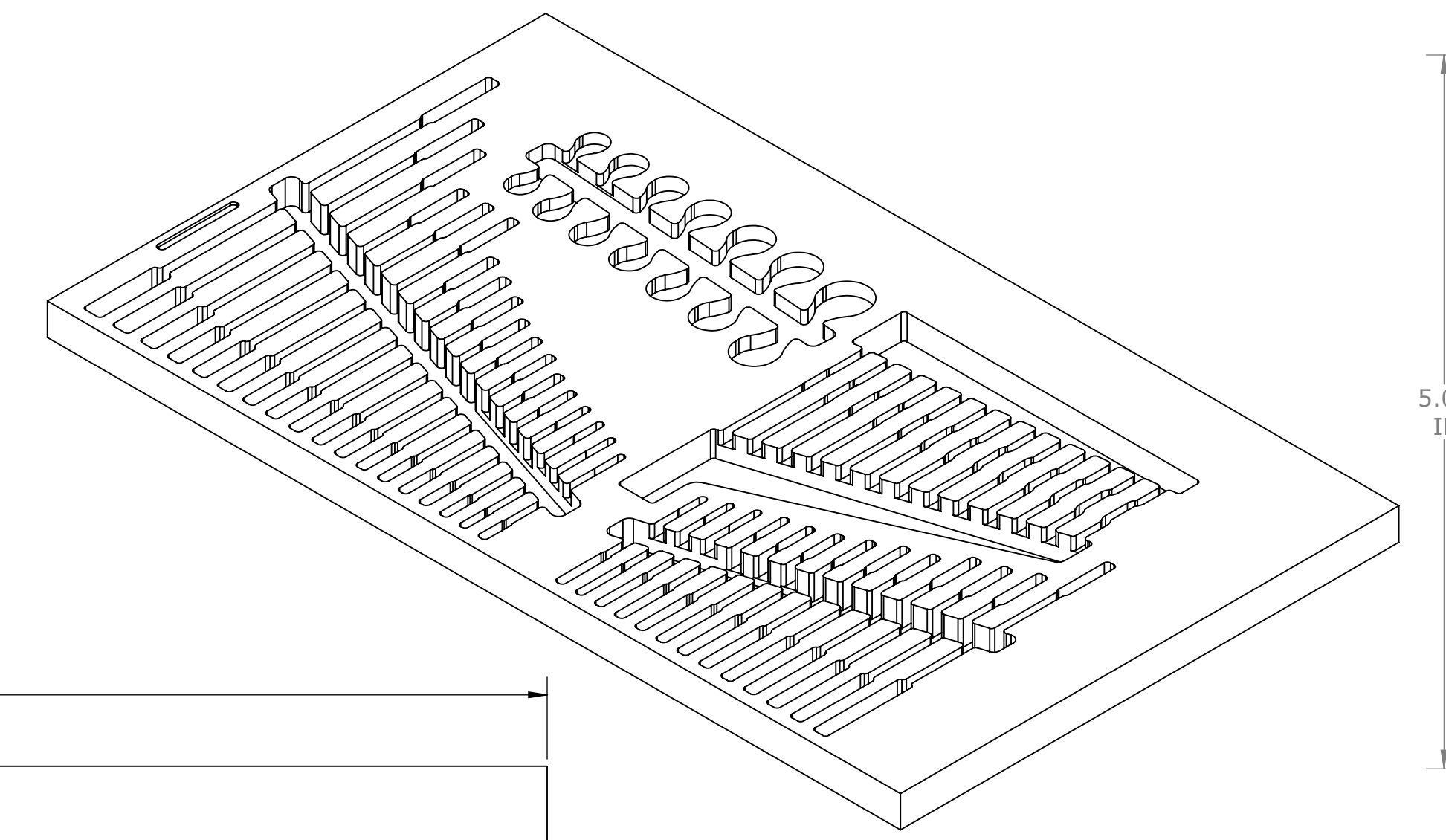

CAUTION  
SUGGESTED DRAWER HEIGHT  
3" MIN

PART NUMBER  
**F-03914-T**

Print on Letter at 100%

1.00 IN

1.00 IN

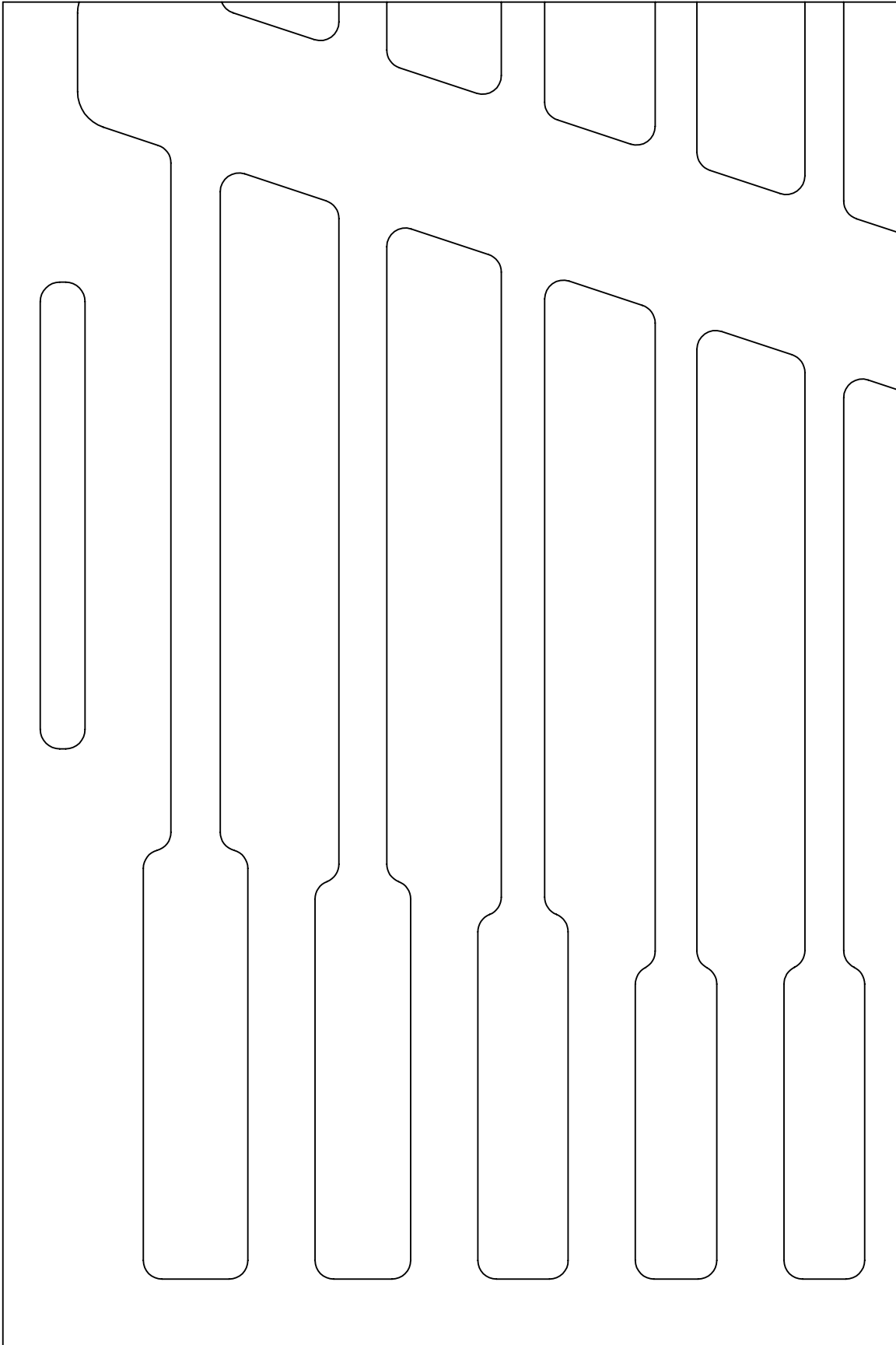

PAGE KEY

X									

DATE CREATED

**13 JAN 2021**

PART NUMBER

**F-03914-T**

X
---

1.00  
IN

1.00 IN

Print on Letter at 100%

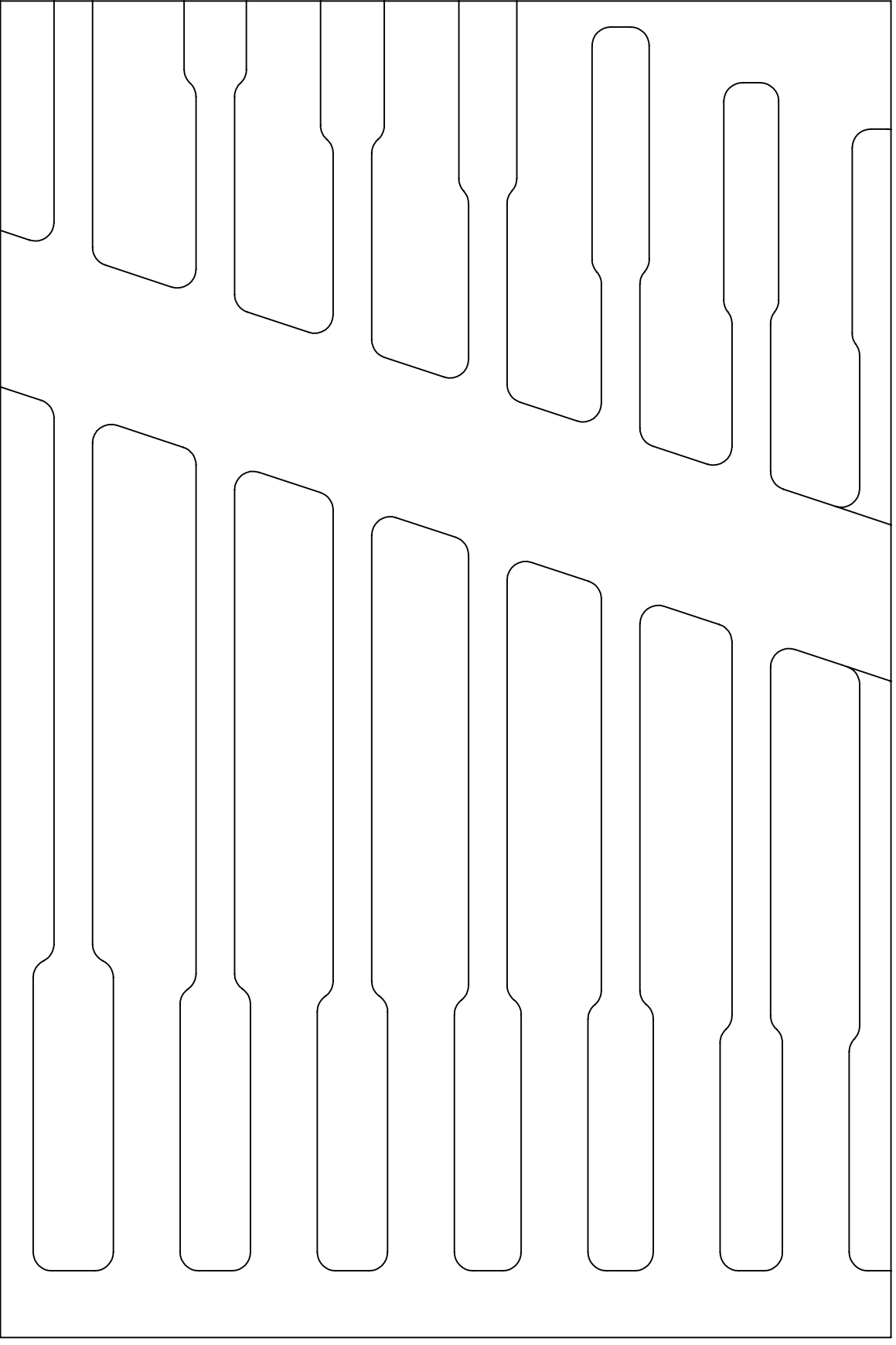

PART NUMBER	DATE CREATED
<b>F-03914-T</b>	<b>13 JAN 2021</b>

1.00 IN

1.00 IN

PAGE KEY



Print on Letter at 100%

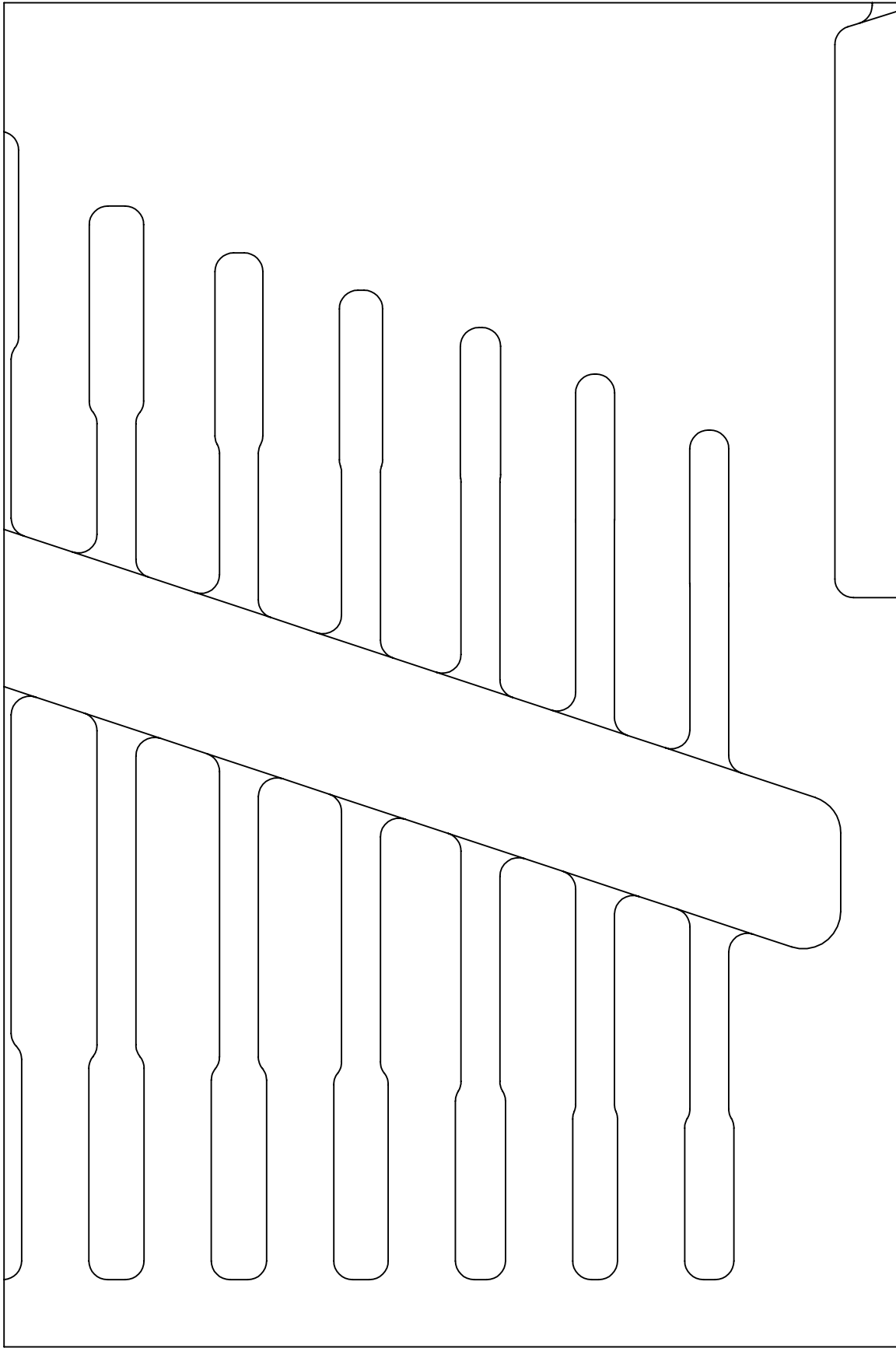

DATE CREATED

**13 JAN 2021**

PART NUMBER

**F-03914-T**

← 1.00 IN →

↑ 1.00 IN ↓

PAGE KEY



Print on Letter at 100%

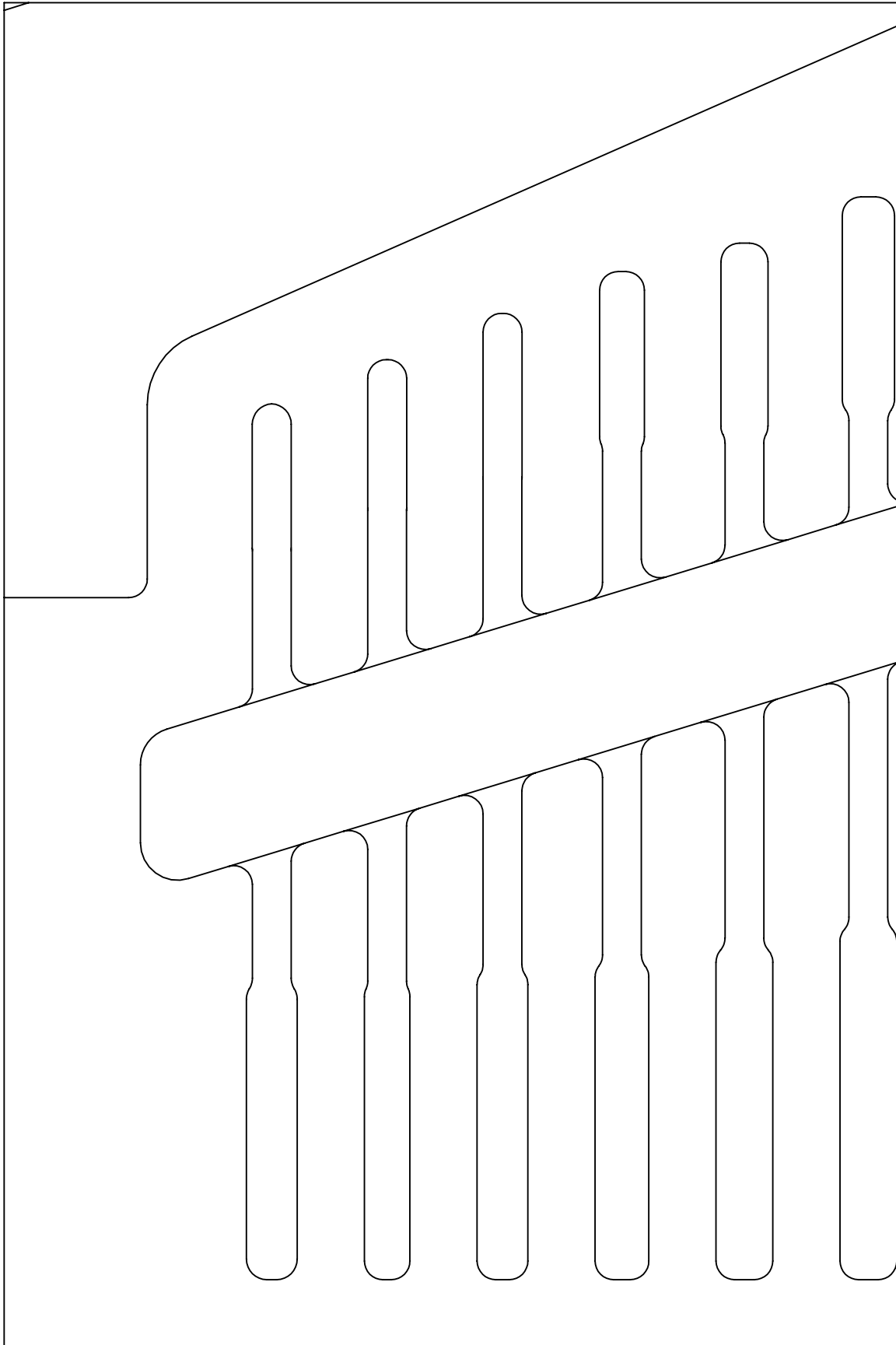

DATE CREATED

**13 JAN 2021**

PART NUMBER

**F-03914-T**

Print on Letter at 100%

1.00 IN

1.00 IN

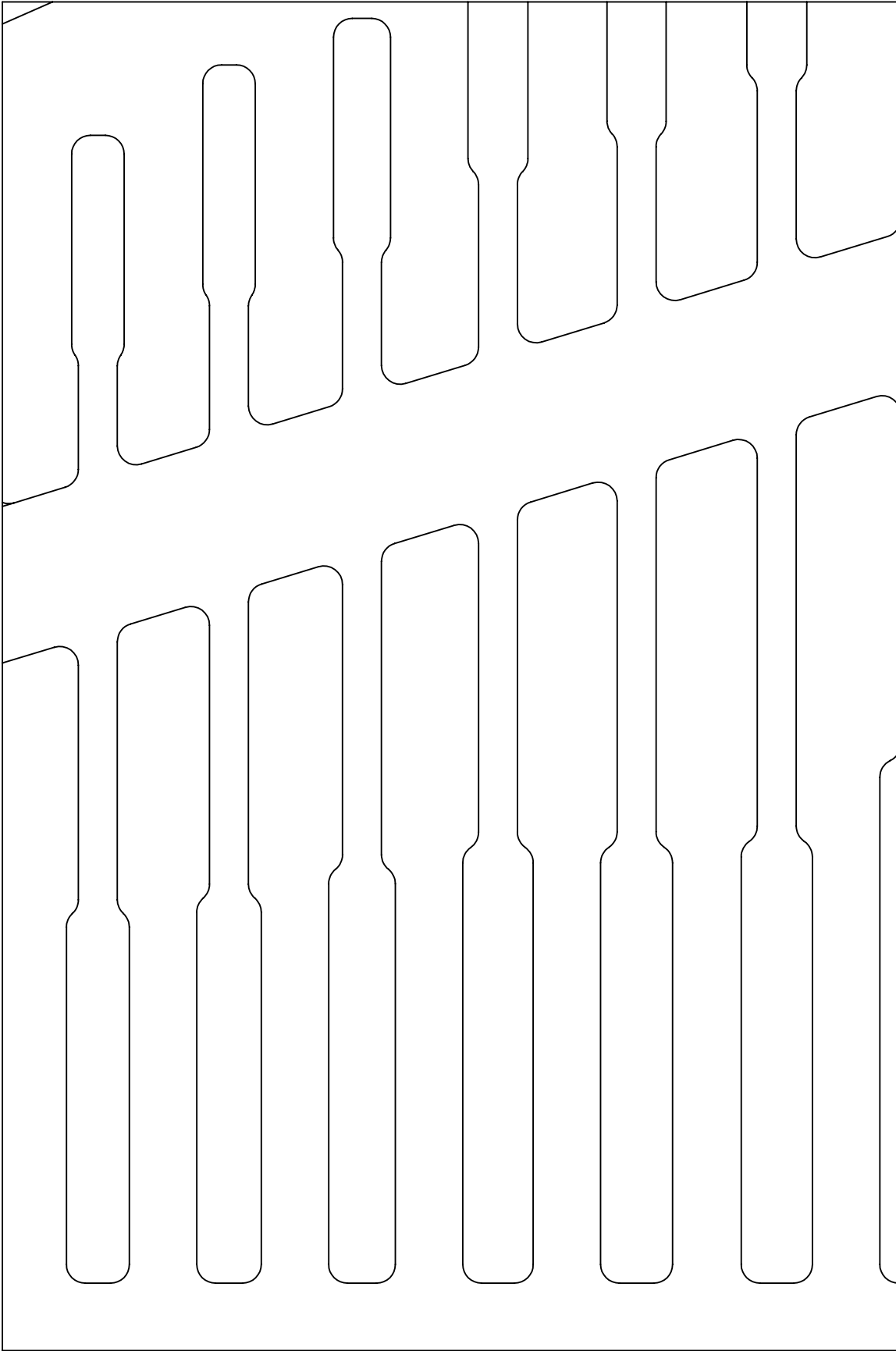

PAGE KEY

									X

DATE CREATED

**13 JAN 2021**

PART NUMBER

**F-03914-T**

Print on Letter at 100%

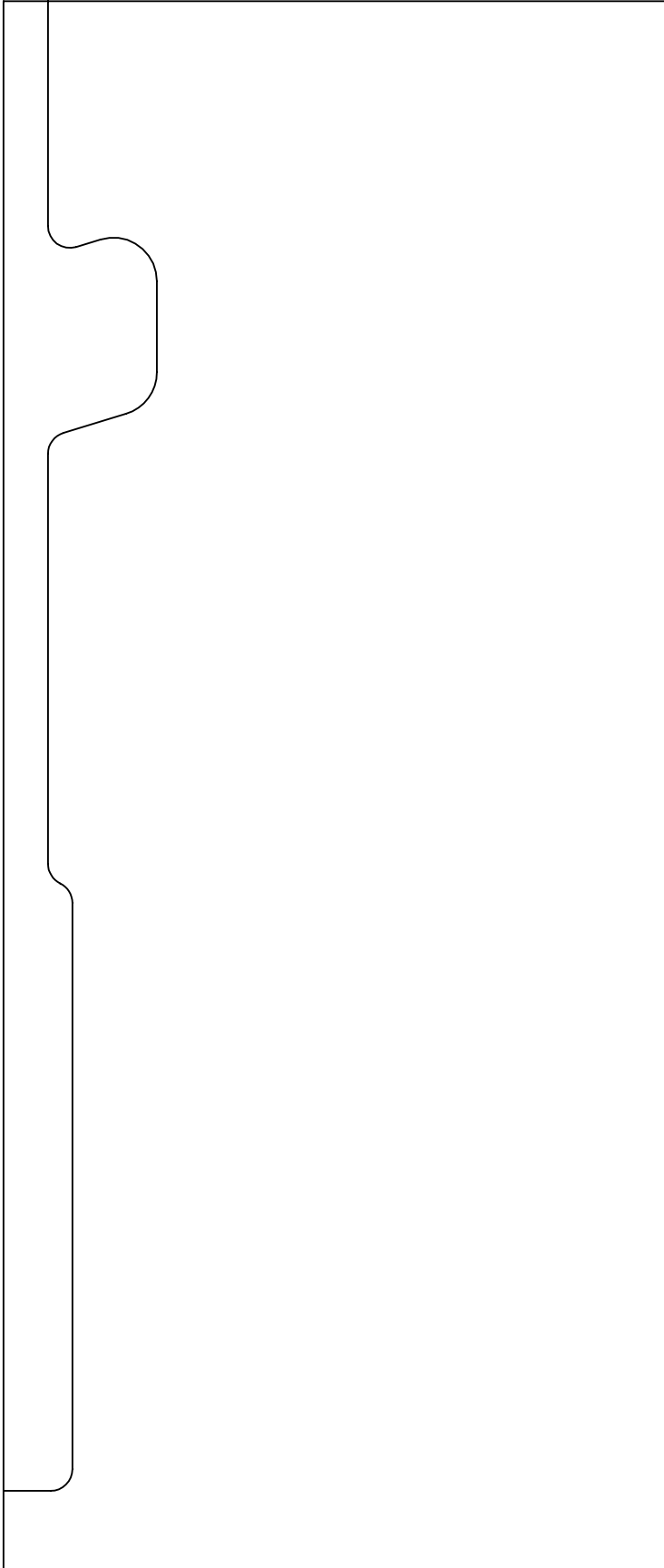

									X

DATE CREATED  
**13 JAN 2021**

PART NUMBER  
**F-03914-T**

1.00 IN

PAGE KEY

X									
---	--	--	--	--	--	--	--	--	--

1.00  
IN

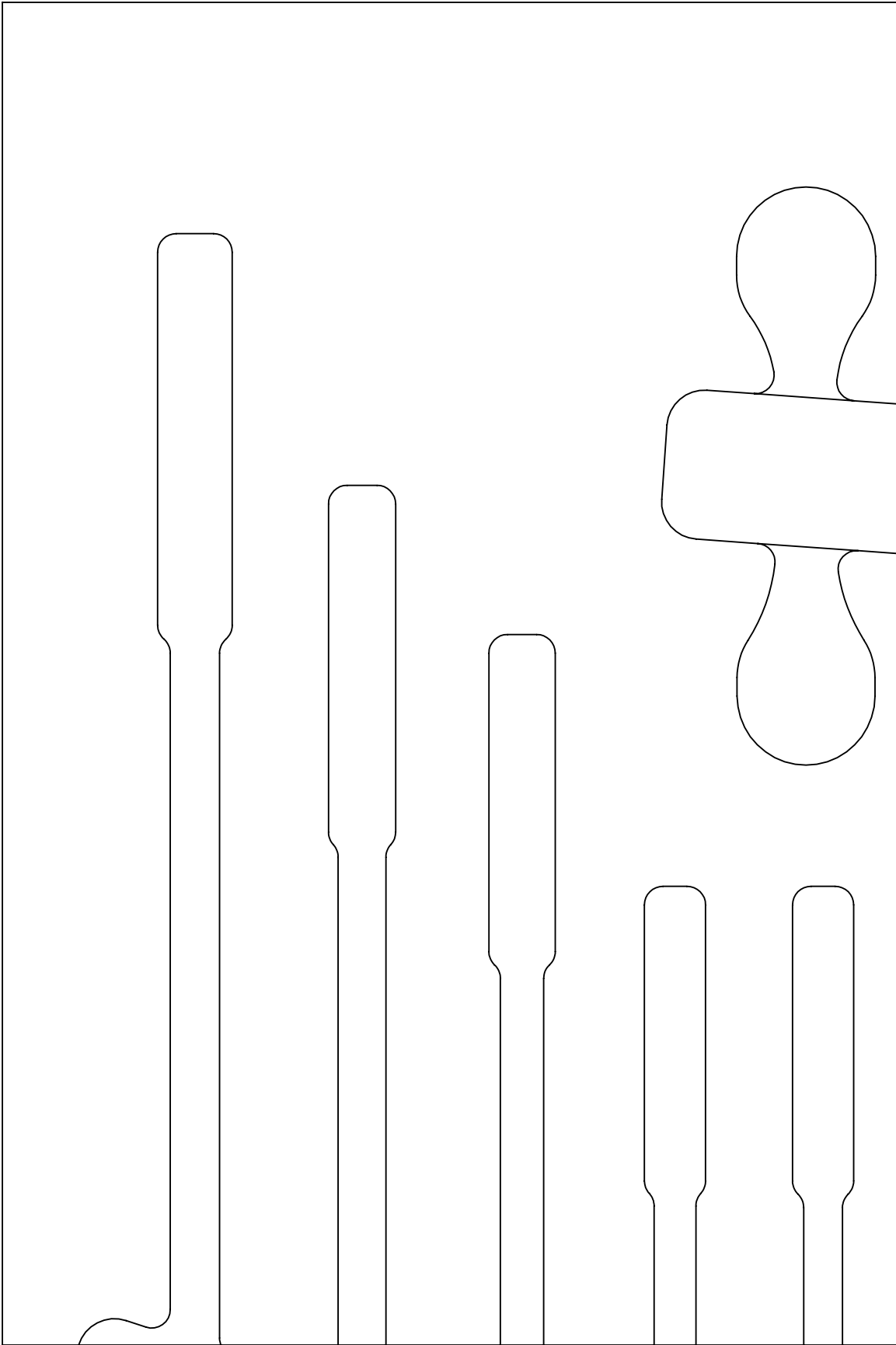

Print on Letter at 100%

DATE CREATED  
**13 JAN 2021**

PART NUMBER  
**F-03914-T**



← 1.00 IN →

PAGE KEY

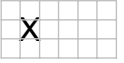

↑ 1.00 IN ↓

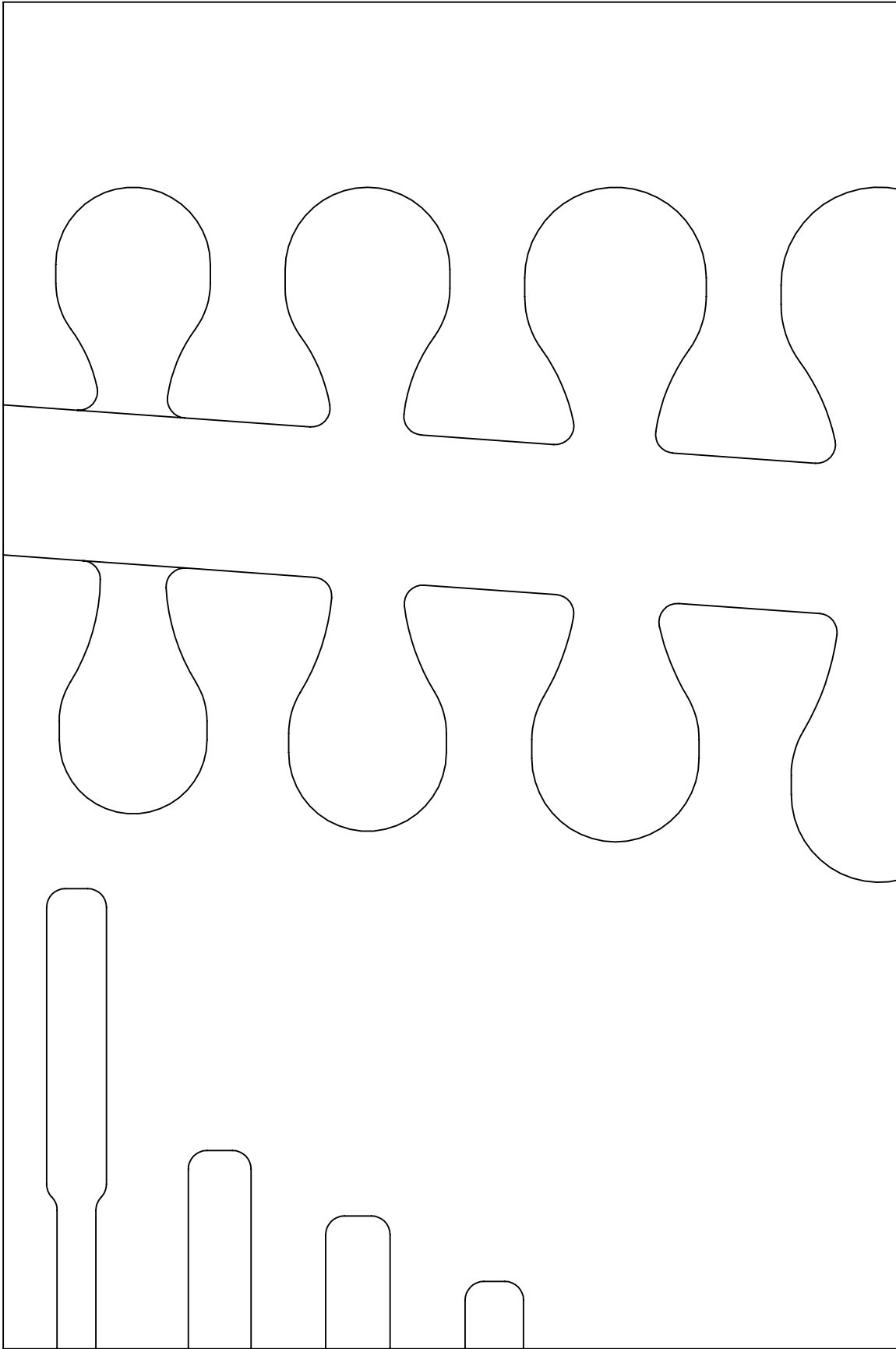

Print on Letter at 100%

DATE CREATED

**13 JAN 2021**

PART NUMBER

**F-03914-T**

1.00 IN

PAGE KEY

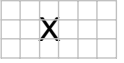

1.00 IN

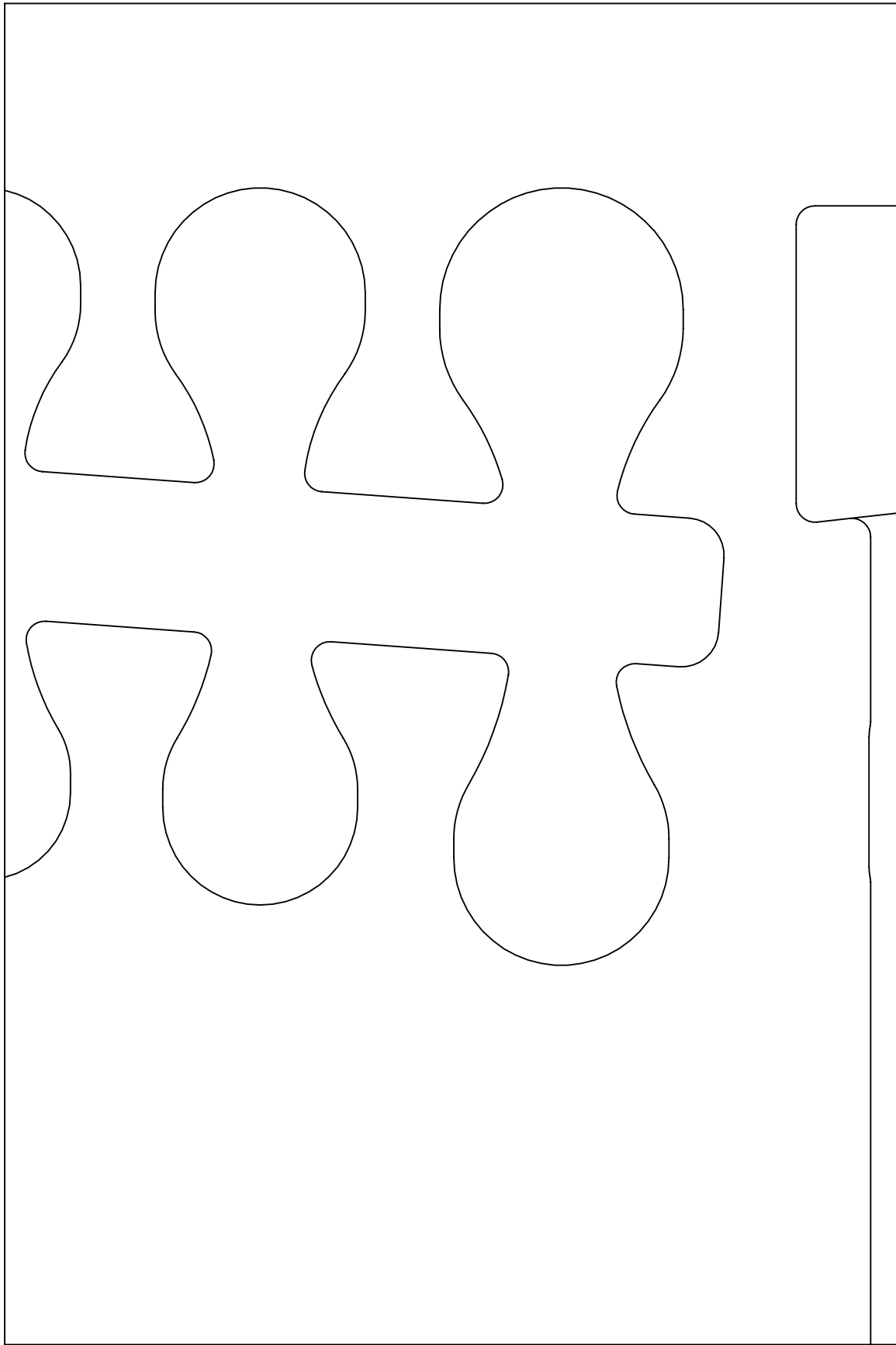

Print on Letter at 100%

DATE CREATED

**13 JAN 2021**

PART NUMBER

**F-03914-T**

Print on Letter at 100%

1.00  
IN

1.00 IN

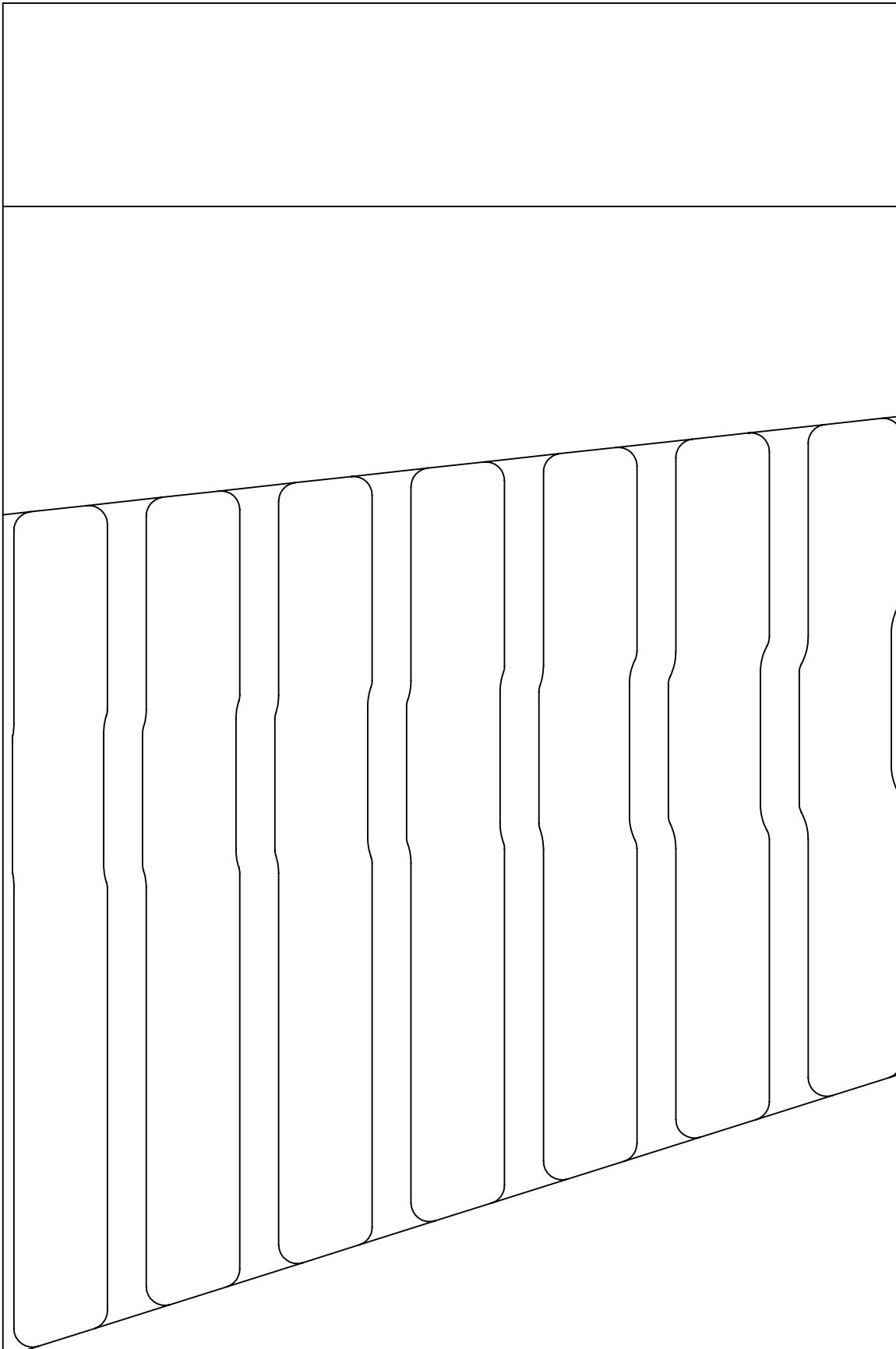

PAGE KEY



DATE CREATED

**13 JAN 2021**

PART NUMBER

**F-03914-T**



1.00 IN

PAGE KEY

			X

1.00  
IN

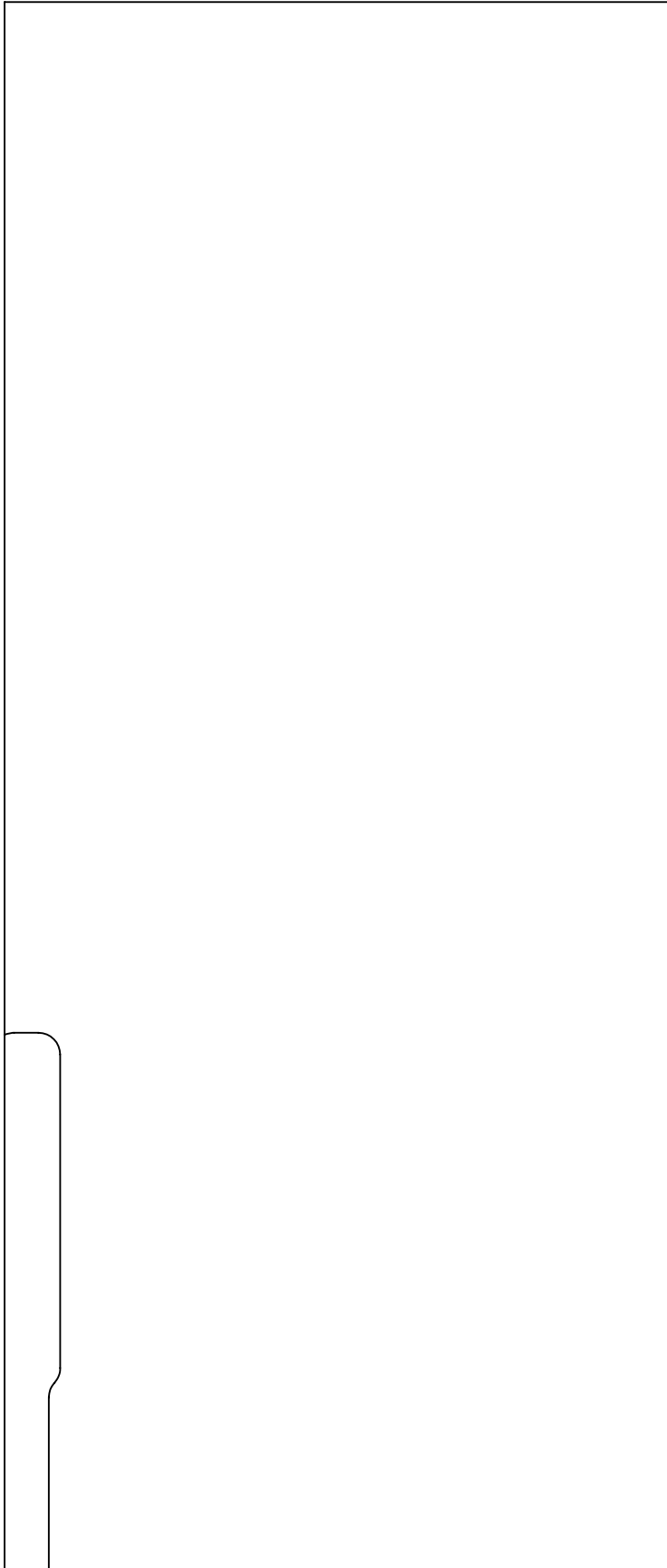

Print on Letter at 100%

DATE CREATED

**13 JAN 2021**

PART NUMBER

**F-03914-T**

← 1.00 IN →

PAGE KEY

X									

↑  
1.00  
IN  
↓

Print on Letter at 100%

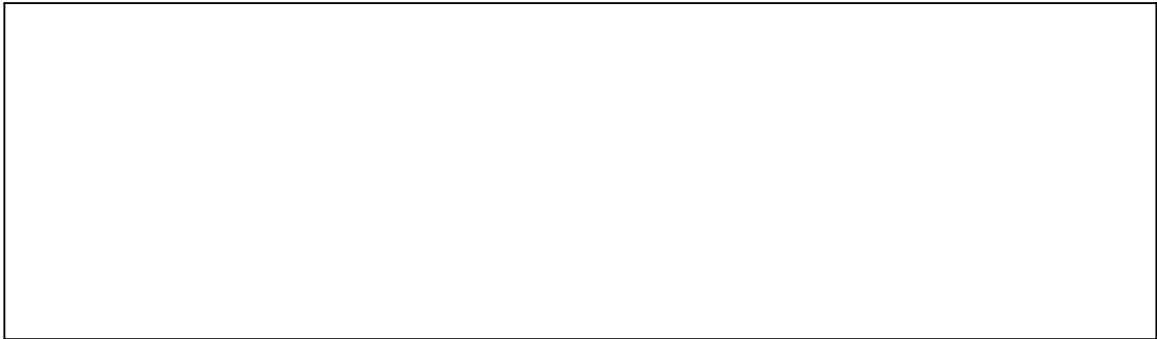

DATE CREATED

**13 JAN 2021**

PART NUMBER

**F-03914-T**

1.00 IN

PAGE KEY

X									

1.00  
IN

Print on Letter at 100%

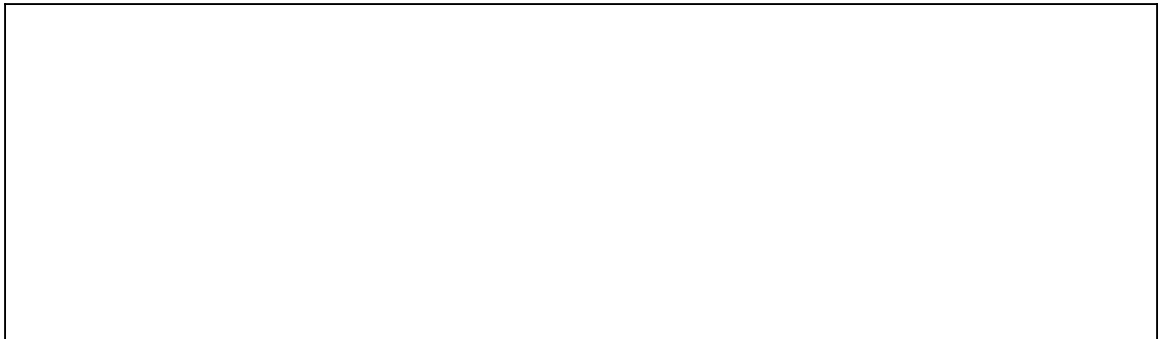

PART NUMBER  
**F-03914-T**

DATE CREATED  
**13 JAN 2021**

	X			

1.00 IN

1.00  
IN

DATE CREATED

**13 JAN 2021**

PART NUMBER

**F-03914-T**

Print on Letter at 100%





← 1.00 IN →

PAGE KEY

									X

↑ 1.00 IN ↓

DATE CREATED  
**13 JAN 2021**

PART NUMBER  
**F-03914-T**

Print on Letter at 100%



← 1.00 IN →

↑ 1.00 IN ↓

PAGE KEY  
X

Print on Letter at 100%

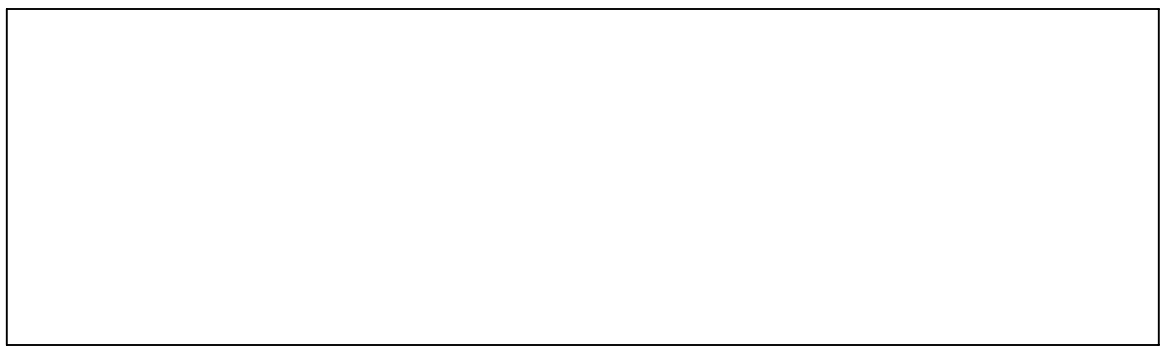

PART NUMBER **F-03914-T**  
DATE CREATED **13 JAN 2021**

1.00 IN

PAGE KEY

											X

1.00  
IN

DATE CREATED  
**13 JAN 2021**

PART NUMBER  
**F-03914-T**

Print on Letter at 100%

