

**PRINTING INSTRUCTIONS**

We recommend printing at full-scale to check the fit with your tools before ordering.

**Option 1:** Print this page full-scale on a large-format printer (E-Size, 44 inches X 34 inches).

**Option 2:** Print page 2 - 16 on 8-1/2 X 11 inch paper and assemble.

**Thank You!**

THE INFORMATION CONTAINED ON THIS DRAWING IS THE SOLE PROPERTY OF FOAMFIT TOOLS AND MAY NOT BE USED WITHOUT PERMISSION. Copyright 2020 FoamFit Tools

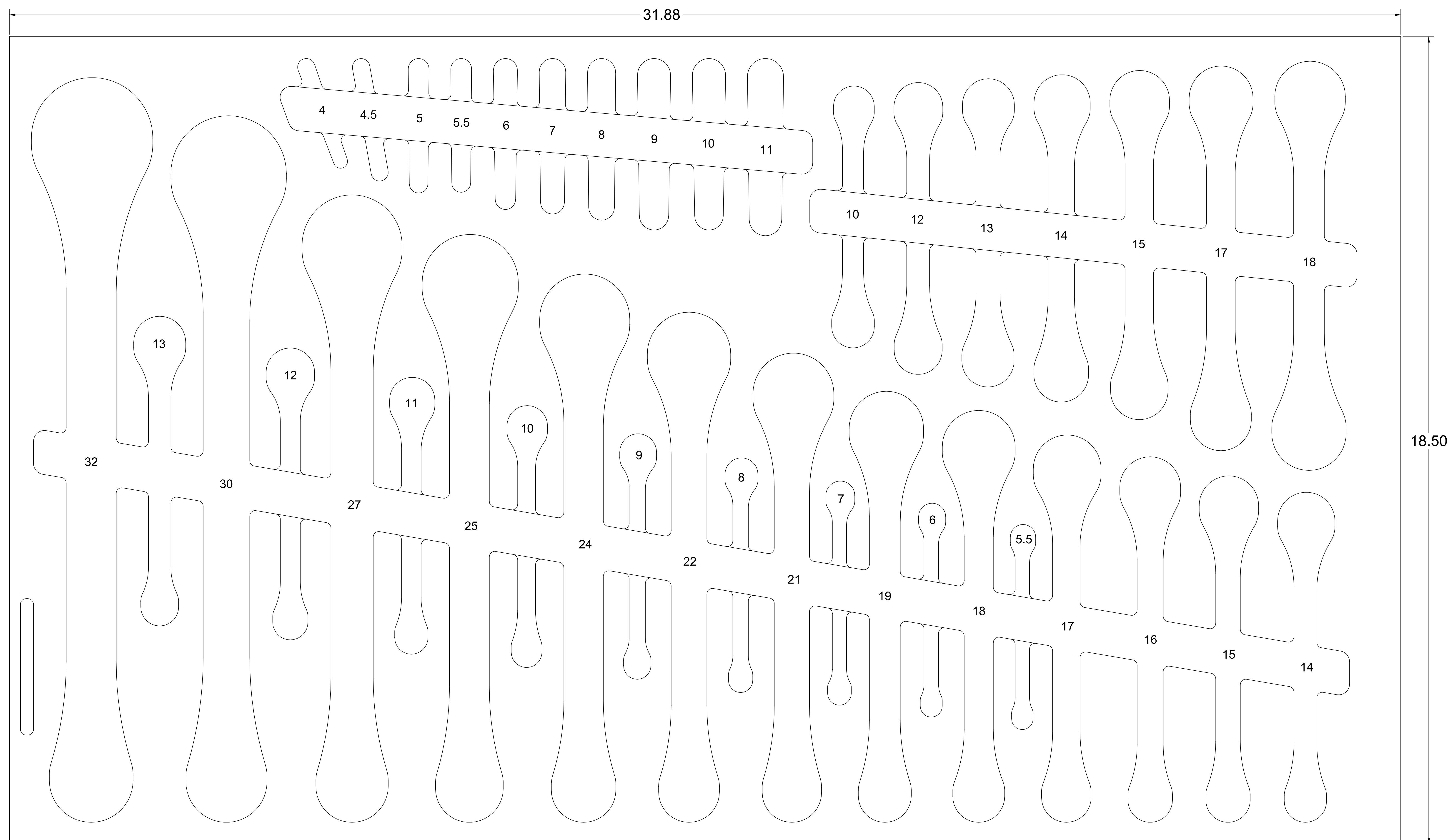
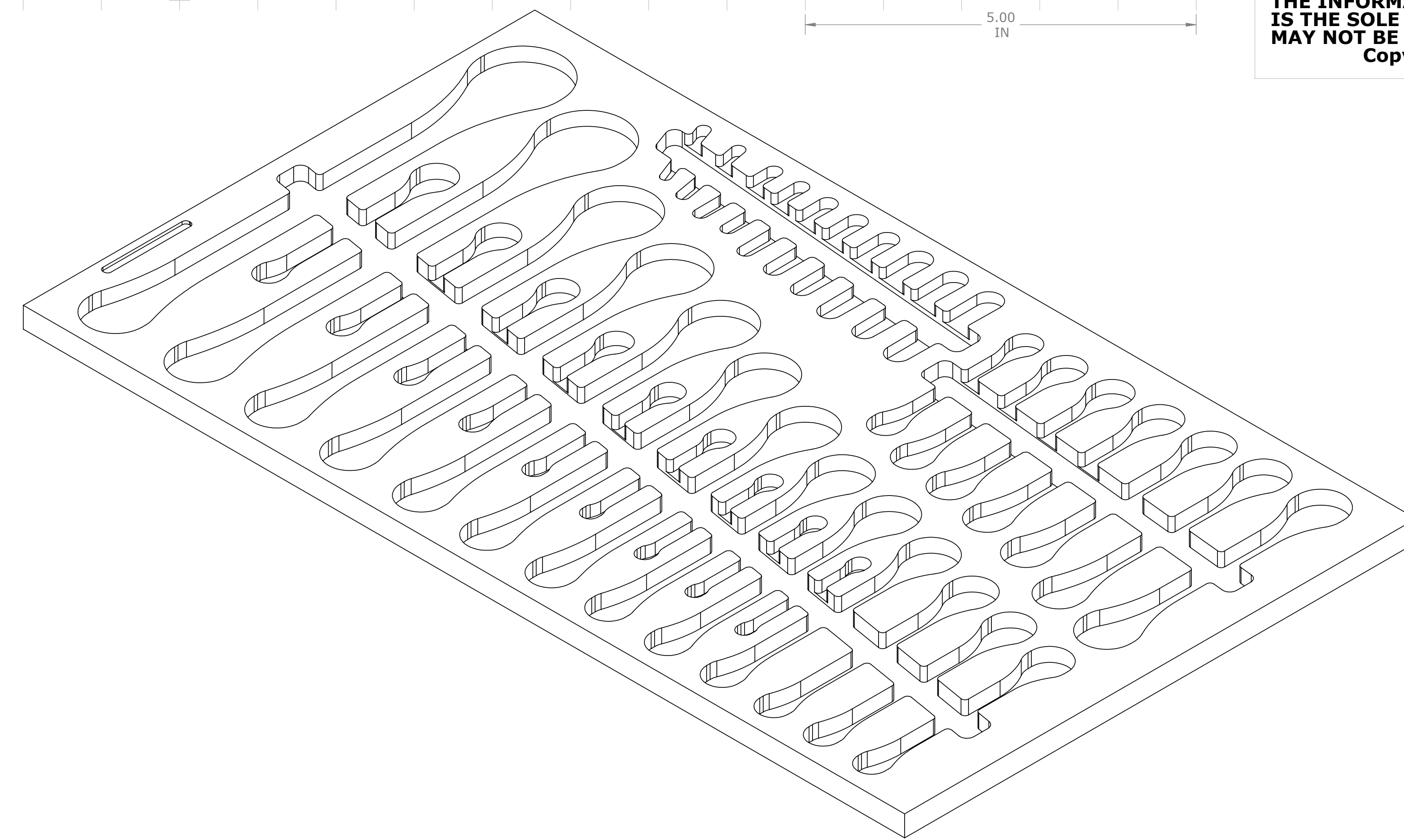

PART NUMBER  
**F-03657-R**

1.00 IN

PAGE KEY

X					

1.00 IN

Print on Letter at 100%

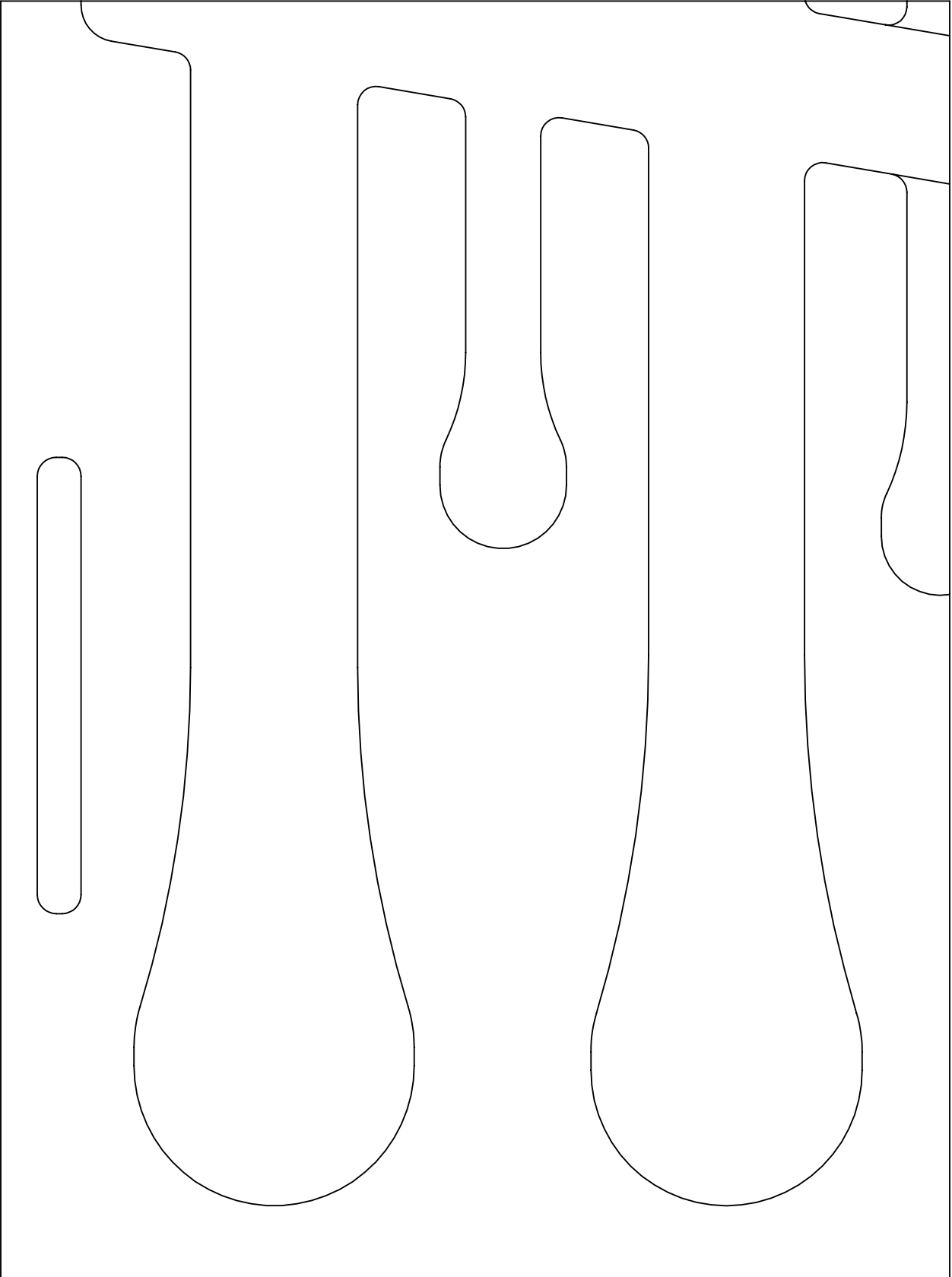

DATE CREATED

**17 JUN 2020**

PART NUMBER

**F-03657-R**

1.00 IN

PAGE KEY



1.00 IN

Print on Letter at 100%

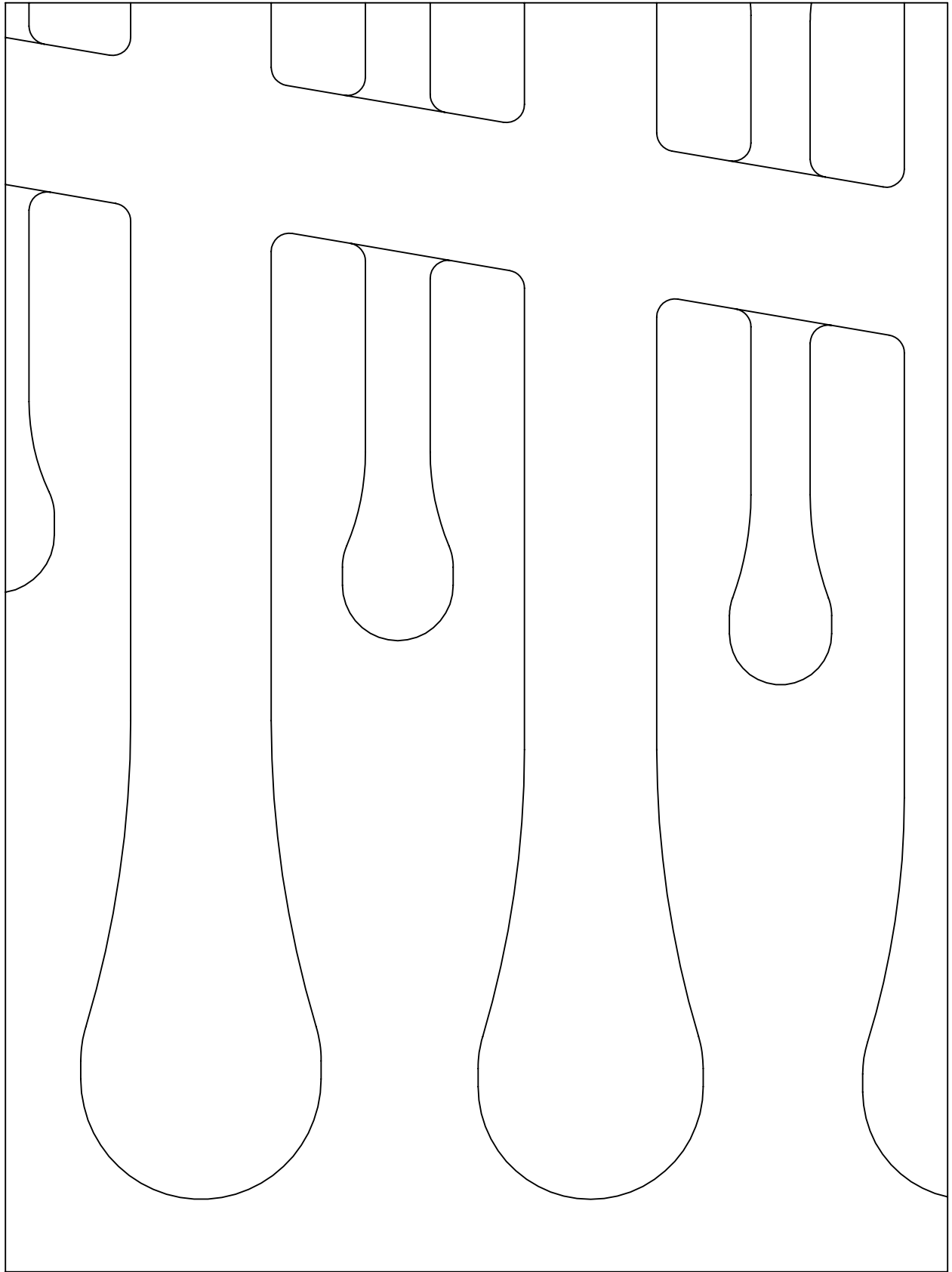

DATE CREATED

**17 JUN 2020**

PART NUMBER

**F-03657-R**

1.00 IN

PAGE KEY



1.00 IN

Print on Letter at 100%

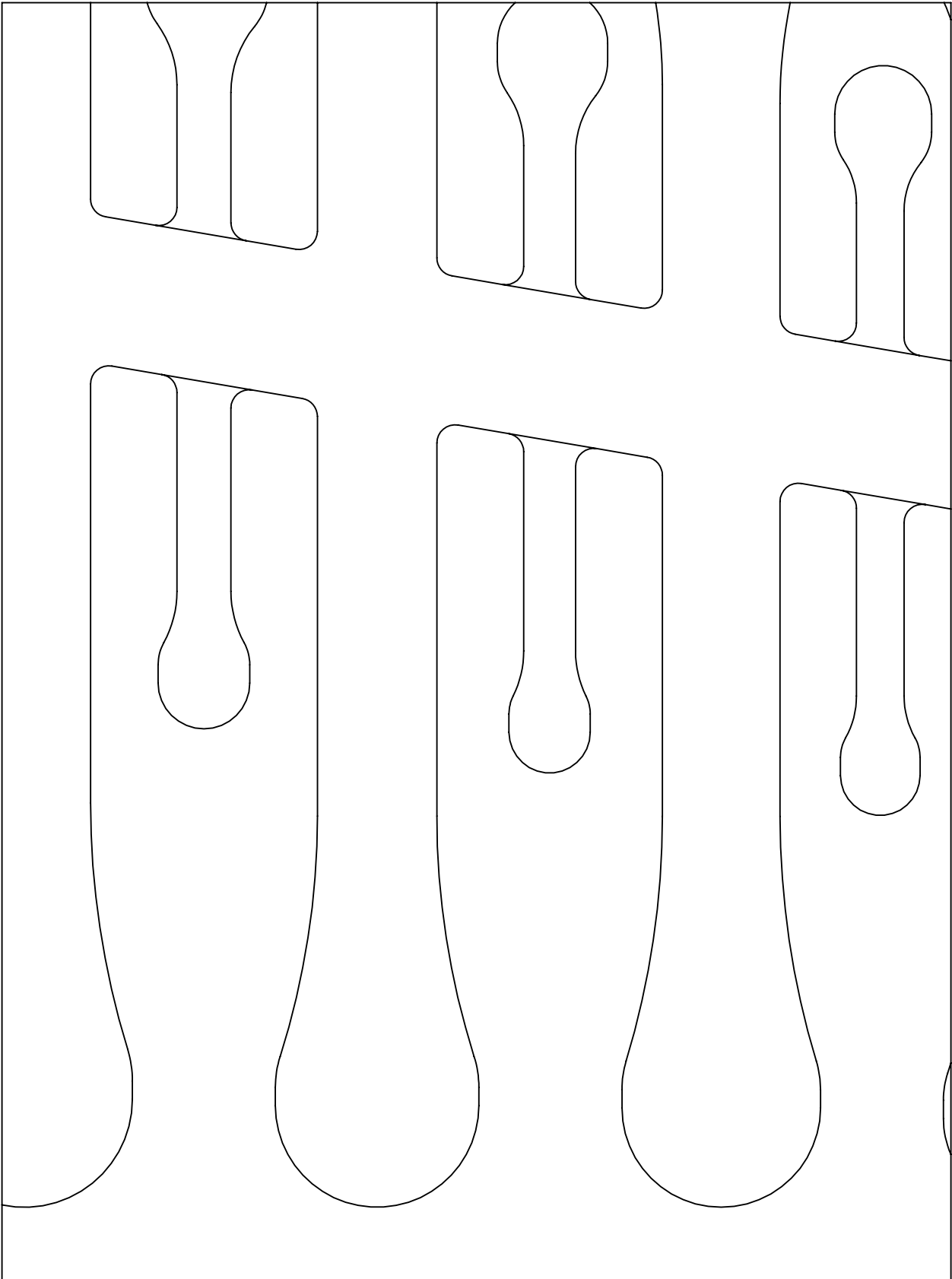

DATE CREATED

**17 JUN 2020**

PART NUMBER

**F-03657-R**

1.00 IN

PAGE KEY



1.00 IN

Print on Letter at 100%

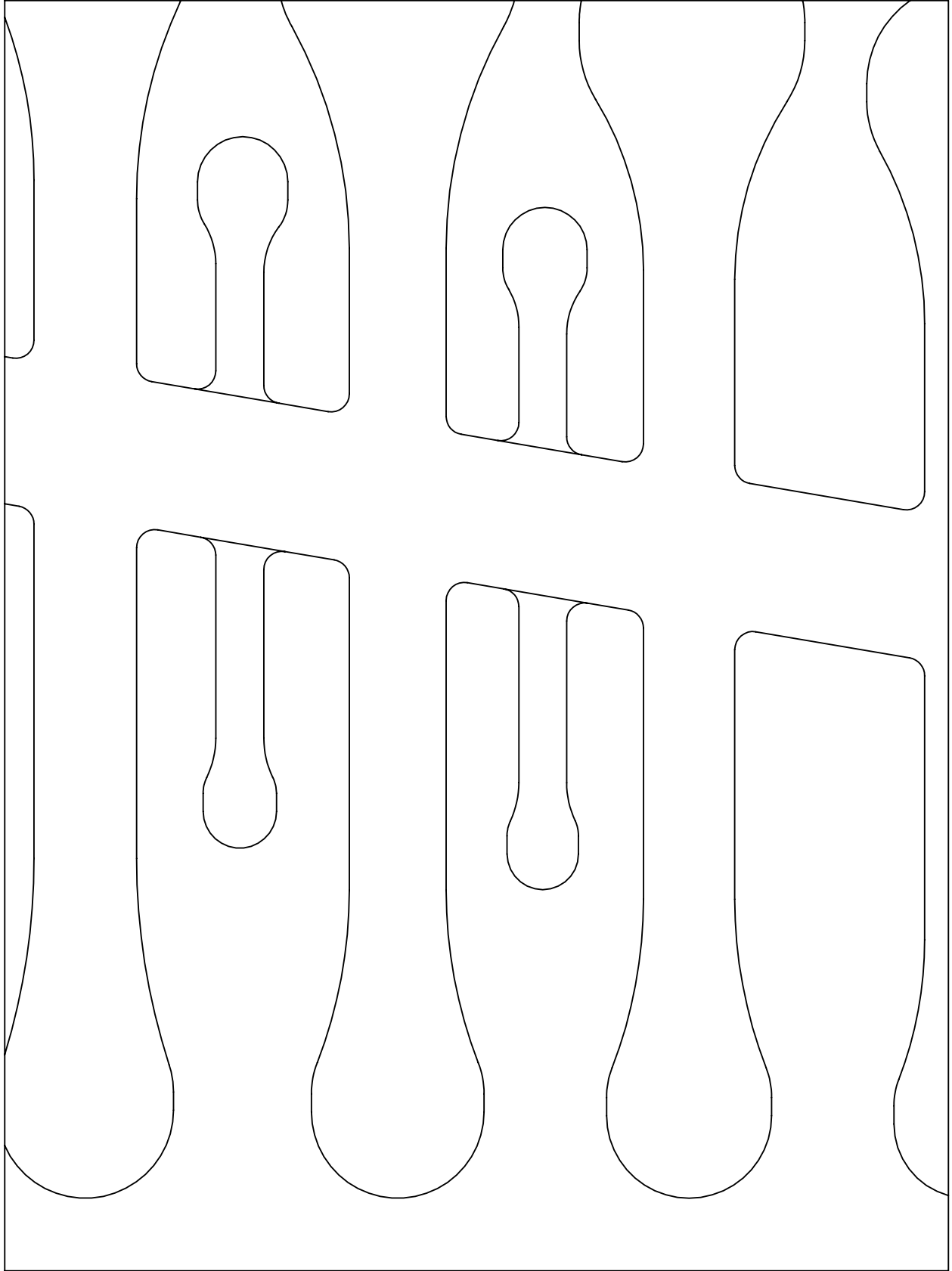

DATE CREATED

**17 JUN 2020**

PART NUMBER

**F-03657-R**

1.00 IN

PAGE KEY



1.00 IN

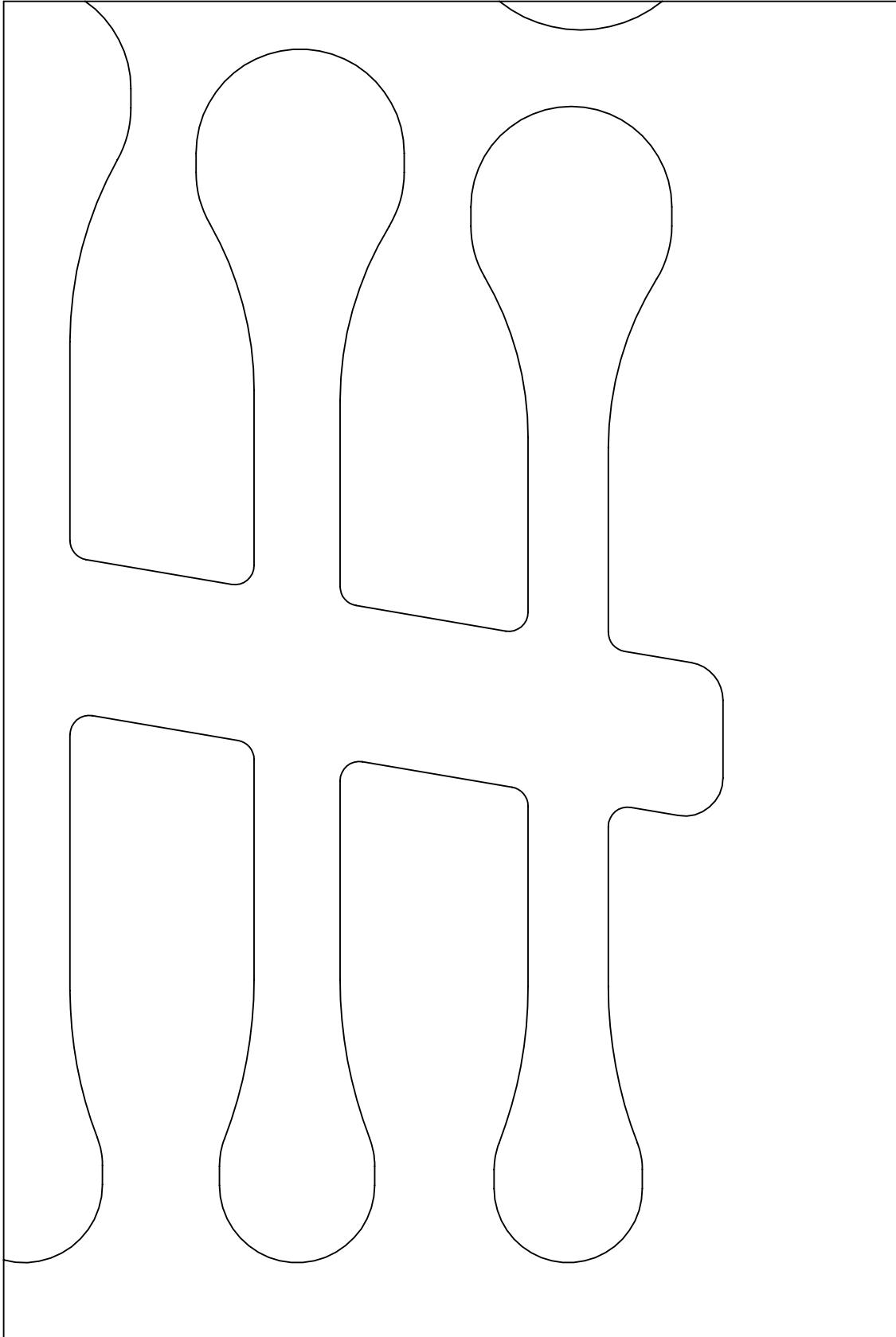

Print on Letter at 100%

DATE CREATED

**17 JUN 2020**

PART NUMBER

**F-03657-R**

1.00 IN

PAGE KEY

X									
---	--	--	--	--	--	--	--	--	--

1.00  
IN

Print on Letter at 100%

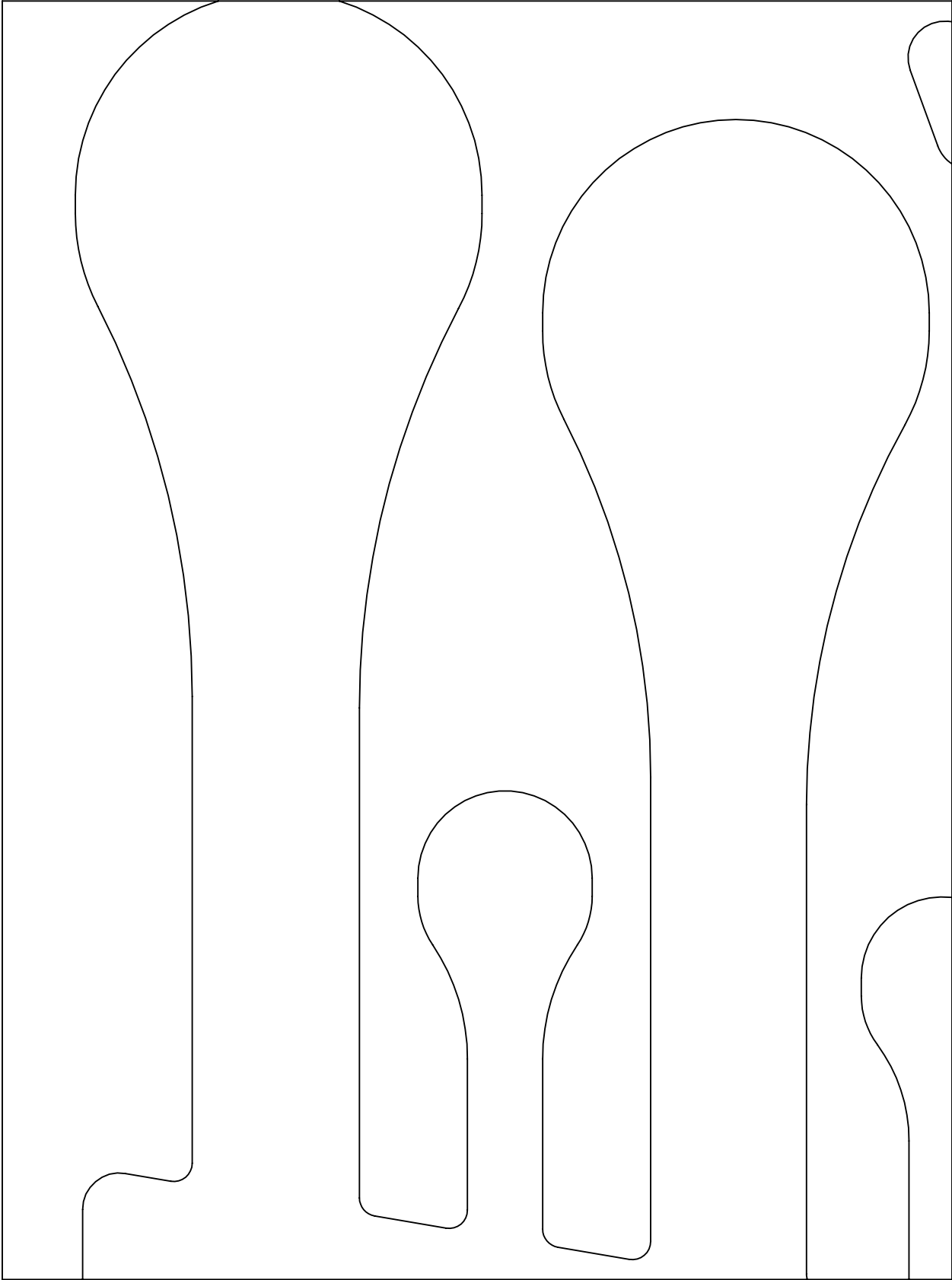

DATE CREATED

**17 JUN 2020**

PART NUMBER

**F-03657-R**

1.00 IN

PAGE KEY

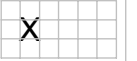

1.00  
IN

Print on Letter at 100%

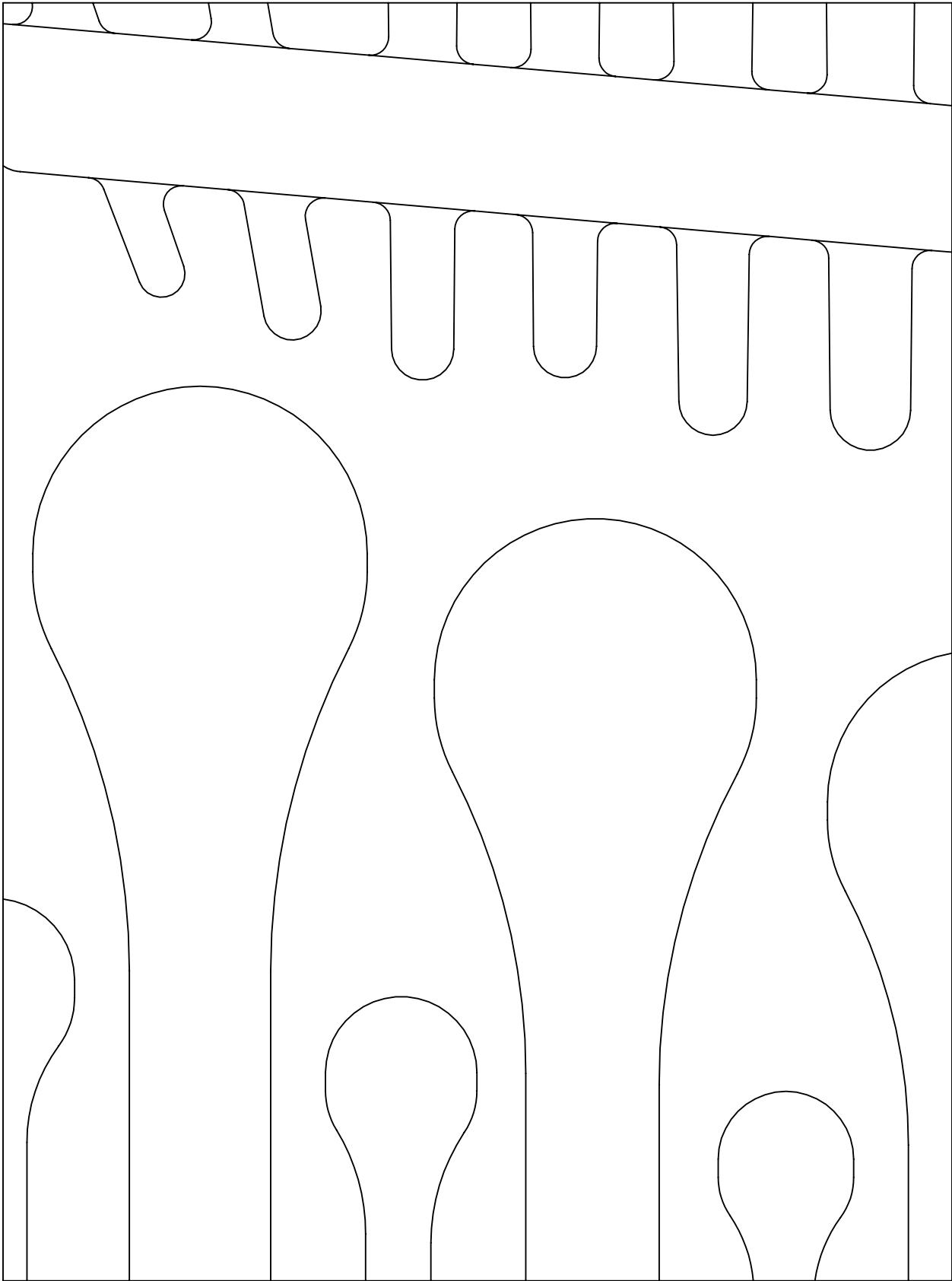

DATE CREATED

**17 JUN 2020**

PART NUMBER

**F-03657-R**



← 1.00 IN →

PAGE KEY

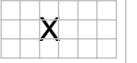

1.00  
IN

Print on Letter at 100%

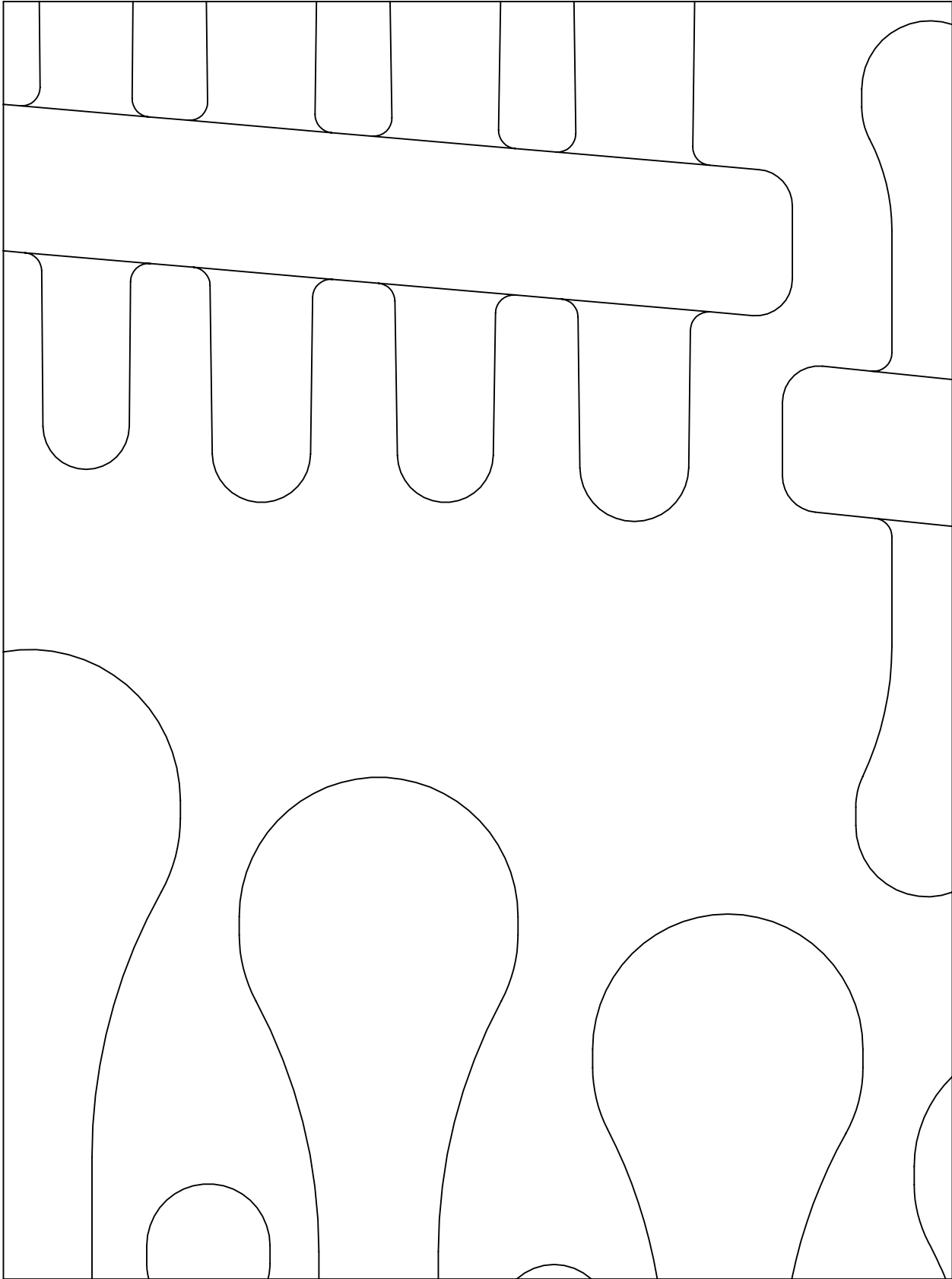

DATE CREATED

**17 JUN 2020**

PART NUMBER

**F-03657-R**

← 1.00 IN →

PAGE KEY

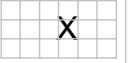

1.00  
IN

Print on Letter at 100%

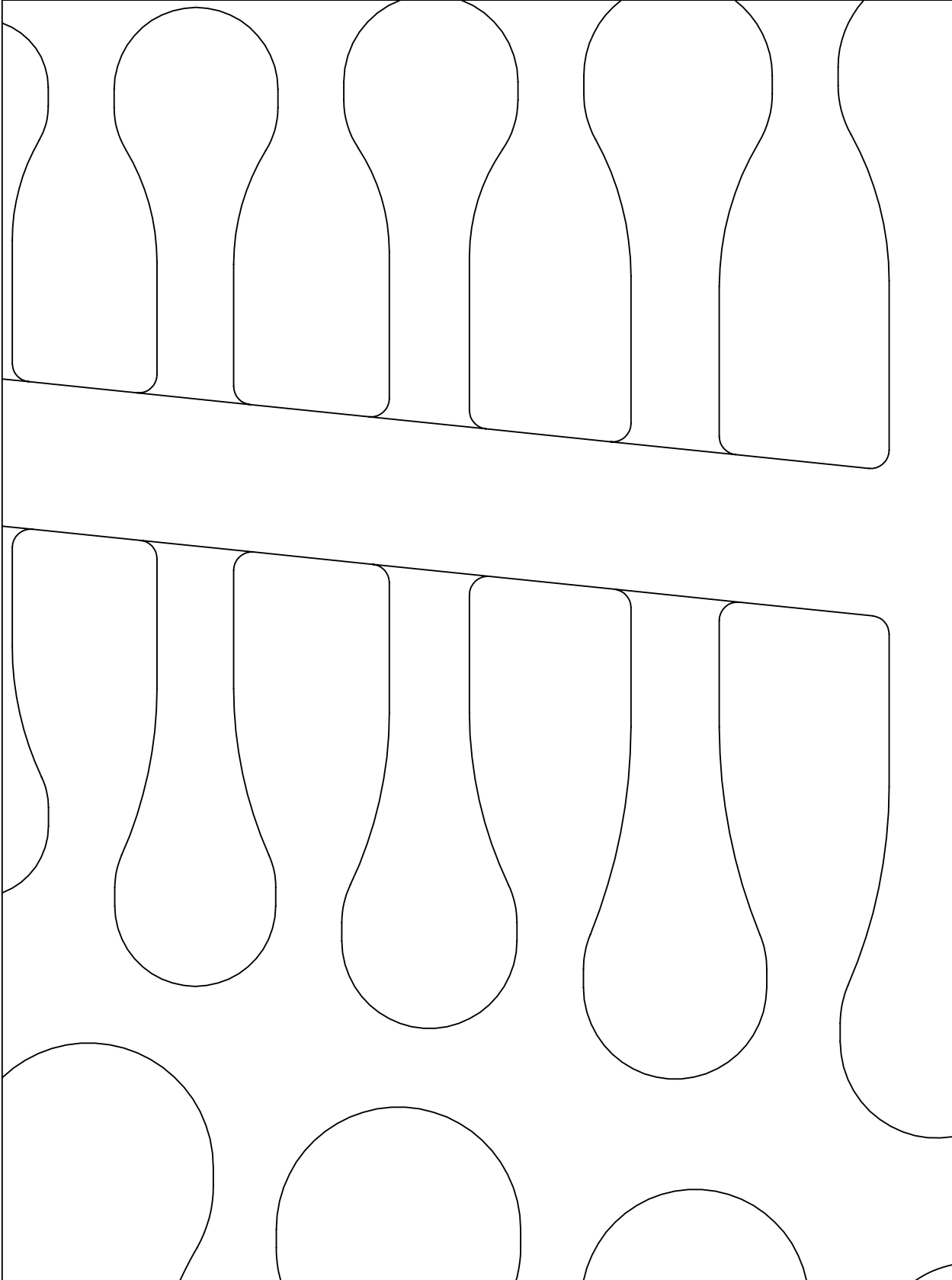

DATE CREATED

**17 JUN 2020**

PART NUMBER

**F-03657-R**

1.00 IN

PAGE KEY

									X

1.00 IN

Print on Letter at 100%

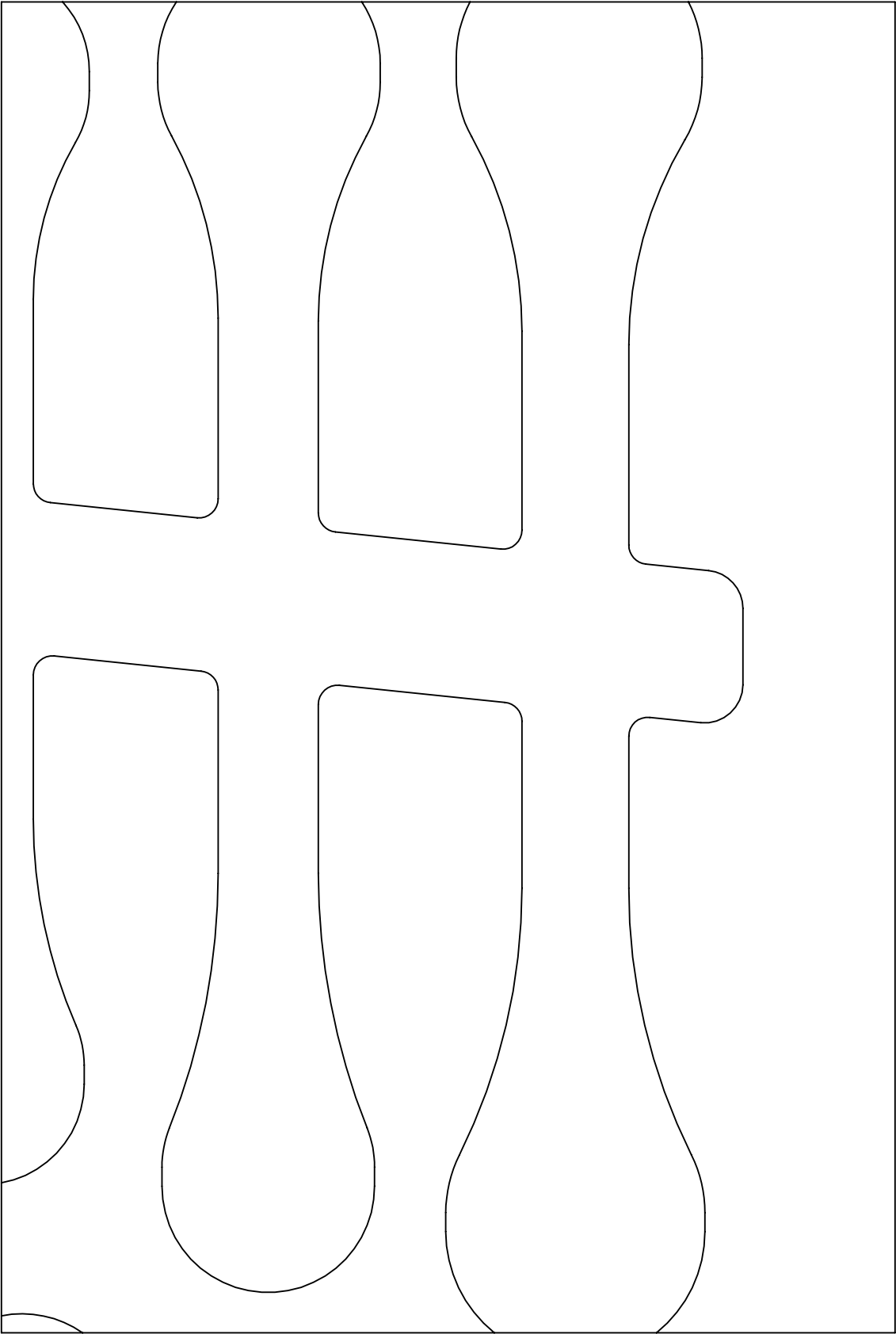

DATE CREATED

**17 JUN 2020**

PART NUMBER

**F-03657-R**

← 1.00 IN →

PAGE KEY

X									

↑  
1.00  
IN  
↓

DATE CREATED  
**17 JUN 2020**

PART NUMBER  
**F-03657-R**

Print on Letter at 100%



← 1.00 IN →

PAGE KEY

X									

↑  
1.00  
IN  
↓

DATE CREATED  
**17 JUN 2020**

PART NUMBER  
**F-03657-R**

Print on Letter at 100%

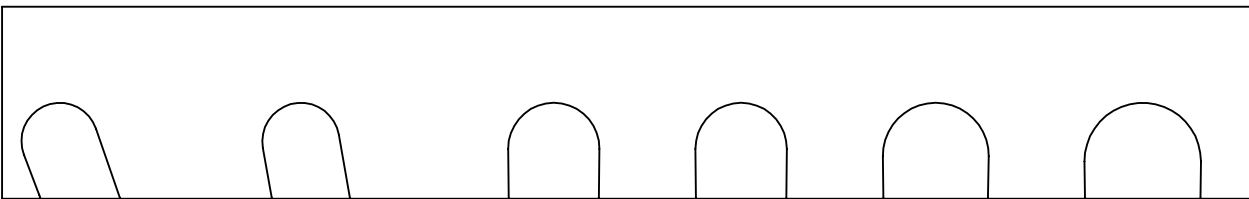

1.00 IN

PAGE KEY

						X			

1.00  
IN

DATE CREATED  
**17 JUN 2020**

PART NUMBER  
**F-03657-R**

Print on Letter at 100%

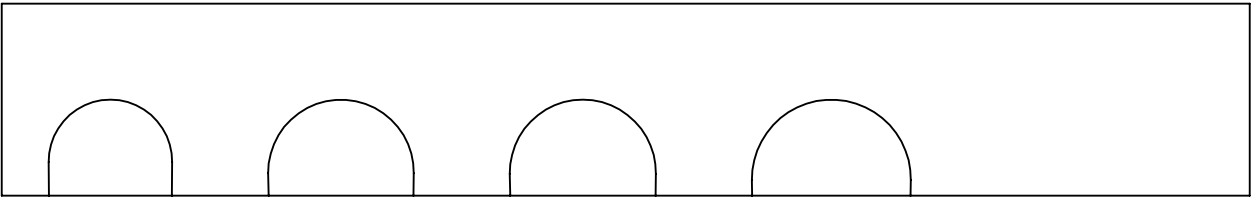

[www.FoamFitTools.com](http://www.FoamFitTools.com)



1.00 IN

PAGE KEY

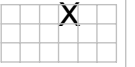

1.00  
IN

DATE CREATED  
**17 JUN 2020**

PART NUMBER  
**F-03657-R**

Print on Letter at 100%

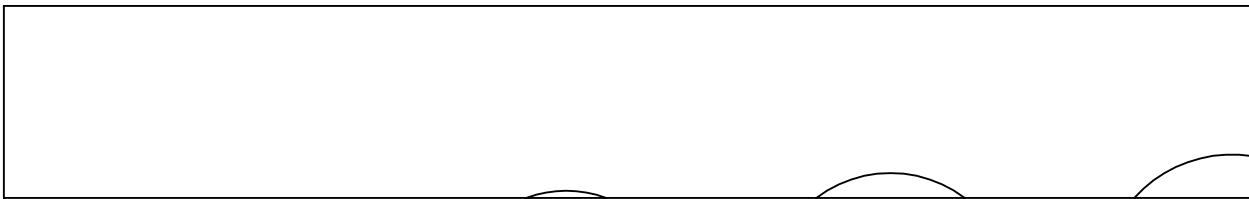

1.00 IN

PAGE KEY

		X		

1.00  
IN

DATE CREATED  
**17 JUN 2020**

PART NUMBER  
**F-03657-R**

Print on Letter at 100%

